

# ONLINE MONITORING OF THE ADS TEST CRYOSTAT COLD MASS WITH WPM

H.Y Zhu<sup>†</sup>, L. Dong, L.L. Men, B. Li, Z.H Wang  
IHEP, Beijing China

## Abstract

Superconducting devices in particle accelerator demand strict operating environment: cryostat with ultra high vacuum and almost absolute zero temperature 2K-4K. This brings a big problem to survey and alignment work: how to preserve the magnets alignment precision in the cryostat, especially after such a big range temperature change. The complicate structure of magnet girder and cryogenic pipes make it difficult to do precise contraction simulation. So wire position monitor (WPM) is designed to measure the device contraction in cryomodule. Accelerator Driven System (ADS) Injector-I is a proton Linac, WPM system was assembled in its first cryomodule TCM. WPM is precisely calibrated, assembled at the same height as magnets. System noise, contraction stability and repeatability are analyzed in detail. Contraction coefficient of girder system is calculated by contraction data and temperature data, the result matches with the thermal coefficient of stainless steel very well. After commissioning, two thermal cycles were recorded, average contraction value was 1.35mm. The commissioning data shows about 0.2mm contraction difference with the same girder structure.

## INTRODUCTION

More and more superconducting technology is used in particle accelerators. These superconducting devices demand strict operating environment: cryostat with high vacuum and almost absolute zero temperature 2K-4K. Regular survey & alignment method only can work at room temperature, there is no precedent alignment experience to realignment the devices within cryostat at any accelerator center [1-3]. The most important issue is how to preserve the alignment precision after big range temperature change. The complicate structure of magnet girder and cryogenic pipes make it difficult to do precise contraction simulation. So, it's necessary to measure the device position all along the thermal cycle in case of any dramatic change during especially cooling down procedure, then get real contraction value to correct devices' center. The wire position monitor is designed to realize this function to monitor the device absolute position change. WPM system was firstly assembled in ADS Injector-I cryomodule TCM

TCM is 2m long, includes two cavities and two solenoids. WPMs are installed at the same height as each device center, as shown in Fig.1. WPM and devices are included within 5K cold shield, connected with G10 girder. G10 is a kind of thermal insulation material.

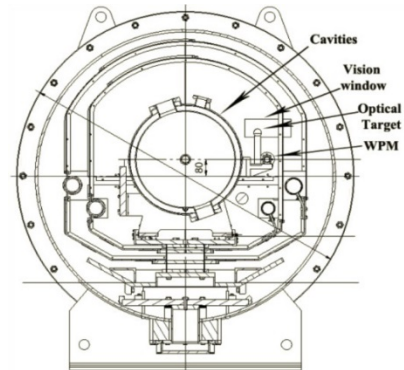

Figure 1: Section view of the cryomodule.

## WIRE POSITION MONITORING SYSTEM

### Principle

The WPM's principle is similar to microstrip BPM's[4], with directional coupler structure. Four electrodes generate induced voltage when an RF signal passes through the center. One can get X,Y position from the voltage on the opposite pairs of strips [5]. Equation 1 is the horizontal direction equation[6-9]. The signal source is a stretched BeCu wire fed with 215MHz RF signal, one end of the wire is fixed to cryomodule end cap, the other end is pulled by 5Kg weight through a pulley to keep the wire straight. So wire position is not affected by the temperature.

$$D_x = \frac{V_B - V_D}{V_B + V_D} = \frac{4\sin(\phi/2)}{\phi/2} \cdot \frac{x}{2b} + \frac{2\sin(3\phi/2)}{3\phi/2} \cdot \left[ \left(\frac{x}{b}\right)^3 + \frac{3xy^2}{b^3} \right]. \quad (1)$$

### Calibration

Because the machine error and nonlinearity, each WPM must be precisely calibrated before installation. According to Eq.1 about third of the diameter is linear area. The WPM diameter is 28mm, so  $\pm 4$ mm is linear area. All the WPMs are calibrated at step of 0.1mm and 0.2mm within  $D/2$ , covering all the linear area and part of nonlinear area[10-11]. The calibration map is shown in Fig.2. The map shows good symmetry in the center and nonlinearity at the edge.

U-V is the sensing voltage at each position, 100mv corresponds to 0.1mm displacement at center[12]. High order polynomials are used to express the nonlinearity between sensing voltage and position

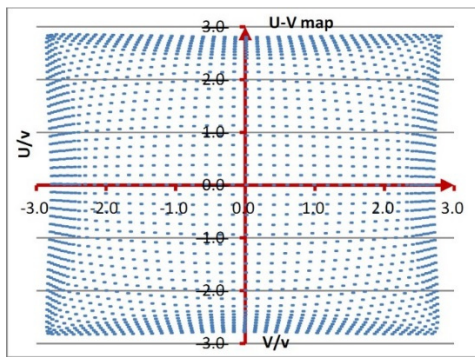

Figure 2: U-V map within ±6mm, 0.2mm step.

$$x = \sum_{i=0}^k \sum_{j=0}^{k-i} A_{ij} U^i V^j, y = \sum_{i=0}^k \sum_{j=0}^{k-i} B_{ij} U^i V^j \quad (2)$$

The fitting error within ±4mm is 3.8µm and 7.4µm respectively in horizontal and vertical direction.

### System Noise

The difference between successive readings of WPM are an indication of the noise level of the system, keeping the wire still allows making an estimate of the upper limit of the noise [7]. Two hours static data was used to do the analysis. The distribution was found to be Gaussian, with an RMS 0.6µm. This is sufficient for Injector-I alignment requirement.

## LIQUID NITROGEN TEST

Before the cryomodule was installed in the tunnel, several experiments were done to make sure the cavities and magnets performance under helium temperature. So we can get real contraction data for each device.

### Vacuum Pump Test

During the vacuum pump stage, a displacement was detected, so two sequent vacuum pump tests were done to check the repeatability. The test results are shown in Fig.3.

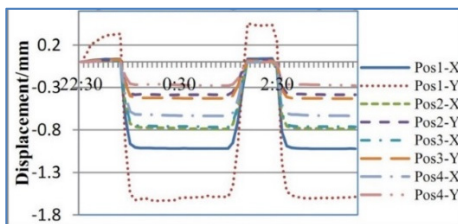

Figure 3: Historical graph of two sequent vacuum pumps.

X and Y represent horizontal and vertical direction. If the displacement is caused by the wire and cryomodule relative movement, the value should be linear change, but they are not, and show much difference and good repeatability. Apparently it is caused by the cavity pressure change.

### Cooling Down Procedure

Historical graph of the vertical direction is shown in Fig.4. Cooling firstly started from 80K cold shield, then 5K cold shield, obvious contraction stage are shown in the historical graph. Final contraction is not even, POS1 and POS2 is about 1.4mm, POS3 and POS4 is about 1.2mm, average value is 1.25mm.

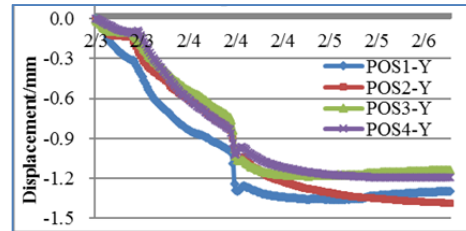

Figure 4: Historical graph of the vertical contraction.

### Cooling Down Procedure

Temperature data was recorded by Cryogenic colleagues. So contraction data and temperature data are combined together to analyze girder's thermal coefficient, as shown in Fig. 5.

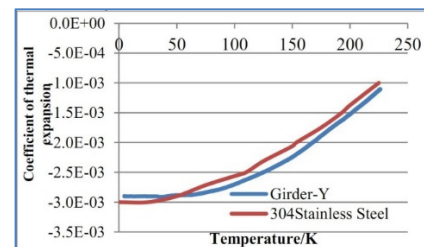

Figure 5: The thermal coefficient of girder and 304.

Two coefficient data matches very well. Although the composition of the girder is complicate, the contraction pattern still mainly follows stainless steel material's thermal expansion law.

Pre-alignment value of devices was set according to the test contraction data and coefficient data, was set to 1.39mm.

## COMMISSIONING

After its commissioning, two thermal cycles were recorded, the historical graph is shown in Fig.6. Because the cooling down process were not exactly the same, two contraction courses are different. In the first cycle, temperature was stable at 4K for two weeks, then went through several ups and downs to 2K. This temperature change had bigger influence in horizontal direction than in vertical direction. Horizontal contraction increased about 0.12mm. But vertical contraction decreased about 0.05mm. The repeatability was very good. Then cryomodule went through a steady warm up process to room temperature, the devices position all recovered within ±0.1mm at both direction. The two thermal cycles are all in vacuum circumstances.

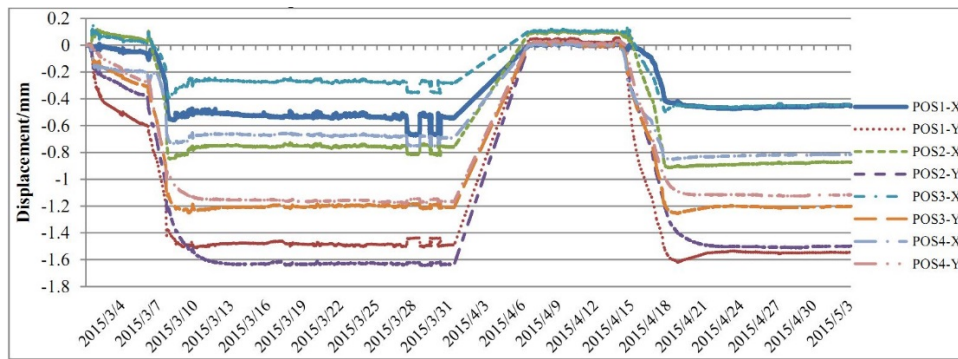

Figure 6: Historical graph of contraction during two thermal cycles.

*Stability of Contraction*

The difference between successive readings of WPM is an indication of the stability of contraction. The distribution of two hours' successive data at 4K of both thermal cycles is shown in Fig.7 and Fig.8. The rms is 3um and 0.62um respectively. According to section 2.3, 0.62um is almost the system noise. Apparently stability of cold mass was improved after several thermal cycles.

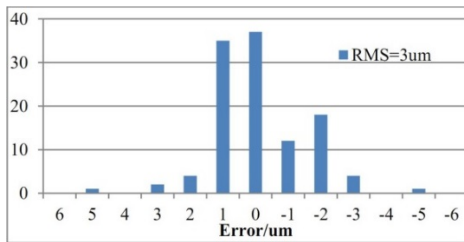

Figure 7: Distribution of the difference in the first cycle.

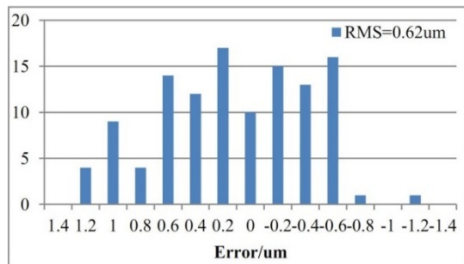

Figure 8: The difference in the second cycle.

*Repeatability of Contraction and Position*

The position and contraction at 4K are compared in Table 1 and 2.

Table 1: The Contraction of Two Thermal Cycles

	First	Second	Difference
S6-X	-0.542	-0.453	0.089
S6-Y	-1.49	-1.543	-0.053
D2-X	-0.759	-0.874	-0.114
D2-Y	-1.636	-1.498	0.137
S4-X	-0.283	-0.446	-0.163
S4-Y	-1.209	-1.202	0.007
D1-X	-0.691	-0.815	-0.124
D1-Y	-1.167	-1.116	0.05

Table 2: Position Difference of Two Thermal Cycles

	First	Second	Difference
S6-X	-1.371	-1.272	-0.099
D2-X	-1.28	-1.206	-0.074
S4-X	-0.48	-0.356	-0.124
D1-X	0.151	0.137	0.014
S6-Y	2.623	2.641	-0.018
D2-Y	0.34	0.197	0.143
S4-Y	1.45	1.346	0.104
D1-Y	-0.25	-0.222	-0.028

The repeatability of contraction is better than 0.2mm in horizontal direction, better than 0.15mm in vertical direction. The repeatability of position is better than 0.15mm in both directions.

**SUMMARY**

Many experiments had been done to test the performance of the WPMs. The monitoring data show that there was no abrupt contraction in all the thermal cycles. Combining the contraction data and temperature data together to analyse the thermal expansion law of the whole girder structure, and the result matches with the stainless steel's expansion law. Based on early experiment result, the reserved contraction value meet the alignment requirement very well.

**REFERENCE**

- [1] Bedeschi *et al.*, "A new wire position monitor readout system for ILC cryomodules[R]", Nuclear Science Symposium Conference Record, 2007.1684-1686.
- [2] A. Sotti, C.Pagani and G.Varisco, "Online Monitoring of the TTF cryostats cold mass with wire position monitors", INFN/TC-00/02, 2000.
- [3] N. Eddy *et al.*, "A Wire Position Monitor System for the 1.3 GHZ Tesla-Style Cryomodule at the Fermilab New-Muon-Lab Accelerator", In *Proc. 15th International Conference on RF Superconductivity*, Chicago,USA, July 2011.
- [4] D. Zhang, A Wire, "Position Monitor for Superconducting Cryomodules at Fermilab", in *Proc. BIW'10*, Santa, U.S.A., May 2010, paper TUPSM031, pp.187-188.
- [5] Ruan Y. F., "The Study of the Beam Instrument for CSNS LINAC", Ph.D. Thesis, CAS. China, 2010.

- [6] H. Y. Zhu and Donglan, "Design and simulation of a wire position monitor for cryogenic systems in an ADS linac[J]", *Chinese Physics C*, vol. 38, No. 8, 2014. DOI: 10.1088/1674-1137/38/9/097001
- [7] W. Coosemans and B. Dehning, "Performance of the wire position sensors in a radiation environment[R]", in *Proc. IWAA99*, CERN, Geneva, Switzerland, 1999.
- [8] C. Deibele, "Synthesis and Considerations for Opti-mally matching to a Beam Position Monitor Circuit Impedance", SNS-NOTE-DIAG-31.
- [9] P. Forck *et al.*, "Beam position monitor[R].", Helmholtz Centre for Heavy Ion Research GSI, Germany, 2008.
- [10] Bowden, Stretched Wire Mechanics, in *Proc. IWAA2004*, CERN, Geneva, Switzerland, October 2004, paper TS08-3.
- [11] G. Stanford, Y. Bylinsky, R.E. Laxdal, "Engineering and Cryogenic Testing of the ISAC-II Medium Beta Cryomodule", in *Proc. LINAC2004*, Lübeck, Germany, 2004, pp.630-632.
- [12] A. Posotti, "The Wire Position Monitor(WPM) as a Sensor for Mechanical Vibration for the TTF Cryomodules", in *Proc. SRF'05*, Cornell University, Ithaca, NY, U.S.A., July 2005, paper ThP43, pp.558-562.