

FULL ENERGY ON-DEMAND BEAM INJECTION FROM SACLA INTO THE SPring-8 STORAGE RING

H. Maesaka[†], T. Fukui, T. Hiraiwa, K. Togawa, T. Inagaki, T. Hara, H. Tanaka
RIKEN SPring-8 Center, Sayo, Hyogo, Japan

H. Dewa, T. Fujita, K. Fukami¹, N. Hosoda¹, E. Iwai¹, A. Kiyomichi, C. Kondo¹, M. Masaki¹,
S. Matsubara, T. Ohshima¹, M. Oishi¹, K. Soutome¹, S. Takano¹, T. Watanabe¹

JASRI, Sayo, Hyogo, Japan

¹also at RIKEN SPring-8 Center, Sayo, Hyogo, Japan

Abstract

We have developed a new beam injection from the SACLA linac to the storage ring of SPring-8 for saving energy consumption and operation cost of existing facilities and for the major upgrade of SPring-8, SPring-8-II. After the upgrade, the storage ring is expected to provide a couple of orders of magnitude lower emittance, but in consequence, the dynamic apertures will be narrower. Thus, the 1 GeV linac and the 8 GeV booster synchrotron that have been used for years will not meet the injection requirement anymore. The SACLA linac can instead provide more than one order of magnitude smaller emittance than the original injectors. We have switched the injectors prior to the major upgrade so that the detailed setup of the new injection system can be precisely completed without affecting the upgrade works. In addition, it can help reduce power consumption and maintenance costs by shutting down the original injectors. We developed an on-demand beam route and parameter switching system, a precise kicker magnet system for beam route control, and a precise synchronization system to inject an electron beam to SPring-8 in parallel with XFEL operation. The systems for the injection worked well and the injector was switched from the original one to the SACLA linac. Although degradation of the bunch purity was observed at first, we minimized the impurity by suppressing the satellite electrons from SACLA and by removing impure electrons in the SR. Thus, both the SPring-8 SR and the XFEL beamlines in SACLA are stably operated with sufficient stability.

INTRODUCTION

In the SPring-8 campus, the third-generation synchrotron light source, SPring-8, and the X-ray free-electron laser (XFEL) facility, SALCA, are co-located and they have been providing brilliant X-rays to experimental users. SPring-8 stably stores an 8 GeV electron beam with an electric current of 100 mA in a 1436 m-long storage ring (SR). The natural emittance of 2.4 nm rad is realized by a double-bend lattice. SACLA produces a low-emittance and high peak-current electron beam with a C-band linac and coherent X-ray radiation is generated by in-vacuum undulators. The electron beam energy is 4–8 GeV and the XFEL photon energy is 4–20 keV. The typical XFEL power is 0.8 mJ per shot at 10 keV. The main linac of SACLA delivers the electron beam to two beamlines, BL2 and BL3,

in parallel. These two facilities were constructed as independent accelerator facilities at different times, but for the future continuous development of the entire facility, it is necessary to promote energy saving, rationalization, and resource saving.

To increase the brilliance of X-rays from SPring-8, we proposed the low-emittance upgrade project, SPring-8-II [1]. The beam energy is decreased to 6 GeV and the emittance is reduced to 100 pm rad or less, which is realized by a five-bend achromat lattice. Since the dynamic aperture becomes significantly narrower, the oscillation amplitude of an injected beam has to be dramatically reduced and a low-emittance injector of less than 500 pm rad is necessary. The original injector of SPring-8, which consists of a 1 GeV linac and an 8 GeV booster synchrotron, cannot be used after the upgrade because of the emittance issue. Therefore, we adopted the time-sharing use of the SACLA linac as the ring injector, which can provide electron beams with sufficiently low emittance of less than 200 pm rad, and constructed a beam transport line from SACLA to SPring-8, XSBT (XFEL to SR Beam Transport line) [2].

The injection from SACLA is also beneficial to current SPring-8 because the energy consumption and the maintenance cost can be saved by shutting down the original injector. This approach also meets the strategy for the continuous and stepwise development of the entire facility. Thus, we have developed the required components to inject the beam from SACLA to SPring-8 and we started beam commissioning of XSBT in advance to SPring-8-II. To achieve stable injection from SACLA, the beam route of SACLA should be switched to XSBT as needed, the beam energy, bunch length, etc. should be changed to the appropriate values for XSBT, and the beam timing should be synchronized to a desired bucket of the SR.

In this article, we describe the requirements for the injection from SACLA to SPring-8 and show the design and basic performance of each component needed for the injection. Then, we report some results from beam commissioning of XSBT and SR injection.

REQUIREMENTS

Required machine parameters for each beam route of SACLA are listed in Table 1. The beam energy, bunch length, peak current, etc. must be switched shot-to-shot according to the destination. The beam emittance of SACLA is small enough, but this emittance should be preserved

[†] maesaka@spring8.or.jp

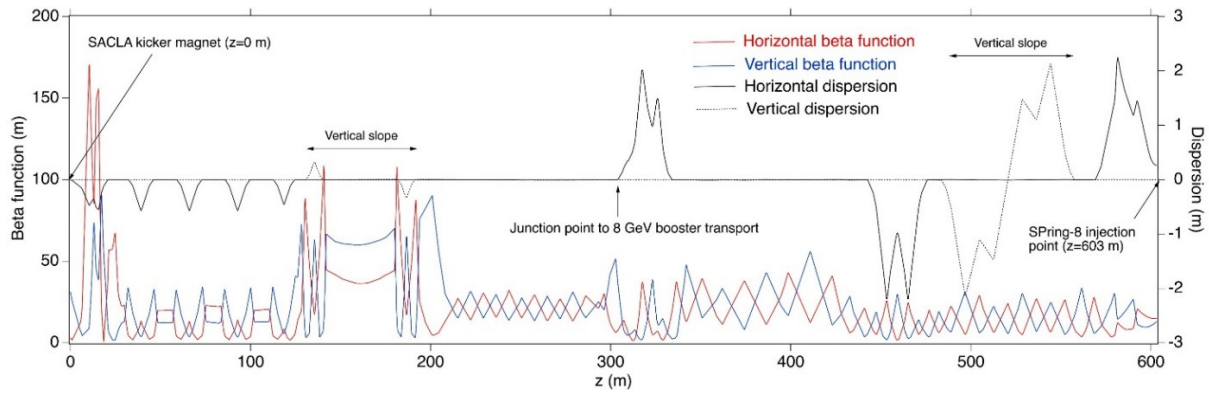

Figure 1: Beam optics of XSBT. The horizontal (vertical) beta function is shown by the red (blue) line. The horizontal (vertical) dispersion function is shown by the solid (dotted) line.

after the beam transport line. If the peak current is too large, the emittance and the energy spread can be degraded by a coherent synchrotron radiation (CSR) effect in an arc section. This is why a bunch length and a lower peak current are better for XSBT.

Table 1: Requirements for Each Beam Route

	SPring-8	SPring-8-II	XFEL
Beam energy	8 GeV	6 GeV	4 – 8 GeV
Bunch length	< 10 ps		~ 10 fs
Peak current	< 1 kA		> 10 kA
Emittance	< 100 nm rad	< 500 pm rad	~ 100 pm rad
Rep. rate	10 Hz (initial) < 0.1 Hz (top-up)		60 Hz max.
Beam route	XSBT		BL2/BL3
Sync. with SR	Yes		No

The synchronization of SACLA to SPring-8 is also necessary for the injection. The timing difference is required to be within 6 ps std. since the bunch length of SPring-8 is about 10 ps. During a user run of SPring-8, the SR beam current is kept constant by top-up injection. The injection rate is less than 0.1 Hz. Therefore, the beam route should be switched to XSBT on-demand basis without affecting the XFEL performance. For a time-resolved experiment at SPring-8, the bunch purity is important to suppress the background from small satellite bunches after the main bunch. The demanded bunch purity is typically 10^{-8} . Therefore, the satellite bunch from the SACLA linac should be eliminated.

COMPONENTS FOR SR INJECTION

According to the requirement mentioned above, we designed and constructed XSBT and developed an on-demand beam route and parameter switching system, a kicker magnet system for the switchyard, and a synchronization system of SACLA to SPring-8.

Beam Transport Line from SACLA to SPring-8

The beam optics of XSBT is plotted in Fig. 1. The beam-line is curved to the direction for the synchrotron by an arc section of a double-bend-achromat-like lattice. The beam-line then goes down to the synchrotron level and merges to the original beam transport line. The beam passes through the underground of the SR, goes up to the SR level inside the ring, and arrives at the injection point. The total length of XSBT is approximately 600 m. To monitor the beam orbit, profile, charge, and loss, we installed 25 stripline beam position monitors (BPMs), 43 screen monitors, 7 current transformers (CT), and an optical-fiber-type beam loss monitor [3].

On-demand Beam Route and Parameter Switching System

To inject an electron beam into the SR in parallel with the XFEL operation, we developed a beam route and parameter switching system for SACLA [4]. A schematic diagram of the system is illustrated in Fig. 2. Beam route information is distributed shot-to-shot from the master unit based on the MicroTCA.4 (MTCA.4) standard. We employed a reflective memory network for the beam route distribution since it has more reliability and better real-time performance than a conventional Ethernet network. The parameter switching function was implemented to a software process running on the CPU in each VME system. This process waits for a new trigger signal, obtains the route information from the reflective memory module, and sets the parameter according to the beam route to each accelerator component.

The beam energy is changed by turning on or off some of the accelerator units [5]. Each C-band accelerator unit can accelerate the beam by approximately 120 MeV, and hence the beam energy can be changed in this step. The bunch length is changed by shifting the RF phase of the accelerator units before the bunch compressors. The beam route is switched by the kicker magnet at the switchyard.

Content from this work may be used under the terms of the CC BY 3.0 licence (© 2021). Any distribution of this work must maintain attribution to the author(s), title of the work, publisher, and DOI

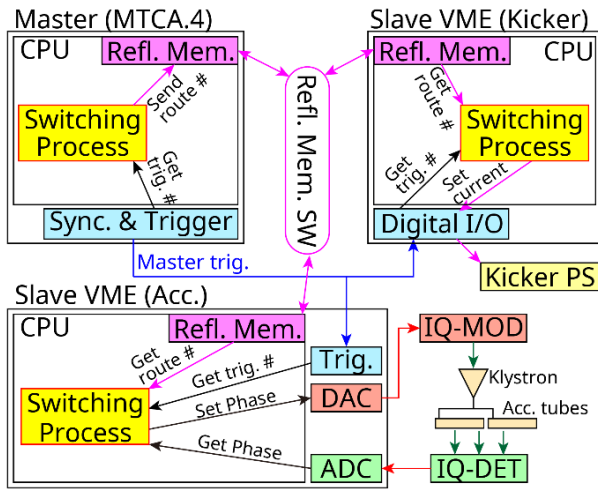

Figure 2: Schematic diagram of the on-demand beam route and parameter switching system.

The beam route is usually switched between BL2 and BL3 one after another. When an injection request is sent to SACLA, an XSBT route is inserted into the routing table. Since the kicker magnet has a hysteresis, we also insert a blank shot after XSBT to restore the magnet condition. In this blank shot, the kicker magnet is excited by an opposite current to the XSBT route. The XFEL operation is appropriately restarted by the suppression of the hysteresis.

Since a software process is used for the switching system, we cannot eliminate failures, such as missing the deadline to set a parameter. We evaluated the failure rate of the switching system in SACLA and the rate was evaluated to be 1×10^{-7} level. This failure rate is well below the trip rate of high-power klystrons and, thus, we can neglect the failure of the switching system practically.

Kicker Magnet

The electron beam is distributed to BL2, BL3, and XSBT by the kicker magnet at the end of the SACLA linac [6]. The length of the magnet is 0.95 m, the maximum magnetic field is 0.9 T, and the bending angle is $\pm 1.5^\circ$. The magnet is driven by a power supply generating a trapezoidal waveform with a repetition rate of 60 Hz. The rated output is ± 1 kV and ± 299 A. To achieve stable XFEL operation, the field stability is required to be within 10 ppm. The field stability was measured by a gated NMR probe and obtained to be 7 μ T peak-to-peak (< 10 ppm), which satisfies the requirement.

Synchronization of SACLA with SPring-8

To synchronize the beam timing from SACLA to the desired bucket of the SR, we developed a precise synchronization system of SACLA to SPring-8 [7]. Since there is no simple rational factor between the master clock of SACLA (238 MHz) and the acceleration RF of SPring-8 (508.58 MHz), we cannot use a phase-locked loop (PLL) for this purpose. Although a PLL can synchronize these signals, the probability to match the edges of both signals is too small and it takes too long to find such a condition.

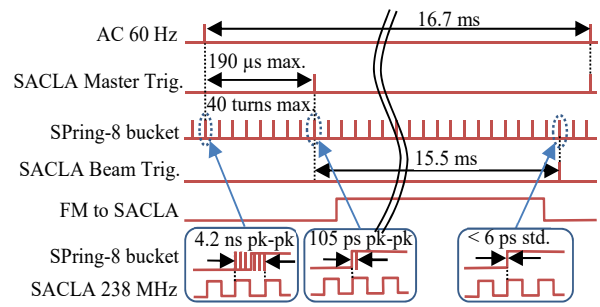

Figure 3: Timing chart of the synchronization system.

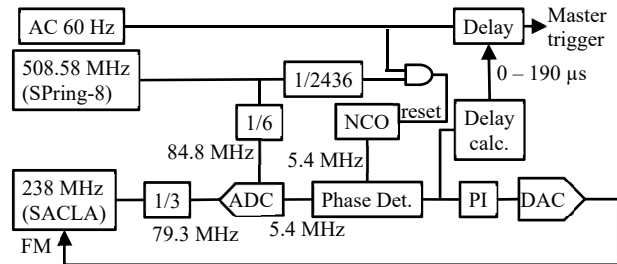

Figure 4: Block diagram of the synchronization system.

Therefore, we decided to apply a frequency modulation (FM) to SACLA to adjust the timing.

The timing chart of the synchronization system is shown in Fig. 3 and the block diagram is illustrated in Fig. 4. The master trigger of SACLA is synchronized to the power line frequency of 60 Hz and the 238 MHz master clock. The SPring-8 bucket signal has a jitter of 4.2 ns peak-to-peak at the master trigger. The FM control is then applied to SACLA so that the bucket timing is synchronized to the master clock and the beam trigger of SACLA within 6 ps std.

The phase difference between SACLA and SPring-8 is detected by a high-speed ADC. The frequency of the SACLA master clock (238 MHz) is divided by 3 and the 79.3 MHz signal is fed into the ADC. The clock of ADC (84.8 MHz) is generated by dividing the SPring-8 RF frequency (508.58 MHz) by 6. The digital data from ADC has a sinusoidal waveform of 5.4 MHz, which is the difference between the input and clock of the ADC. The phase difference of these signals is calculated in the FPGA on the ADC module with a numerically controlled oscillator (NCO) at 5.4 MHz. The phase difference is used for the FM control with a PI feedback loop. These synchronization algorithms were implemented to MTCA.4 modules, Struck SIS8300L2 and an original rear transition module.

Although this synchronization system worked well, some of the components, such as a mode-locked laser for SACLA users, were affected by the FM control. Therefore, we implemented an additional function to reduce the modulation depth. The jitter of 4.2 ns before the FM control can be reduced by waiting for certain revolutions of SPring-8. If the maximum turns to wait is N , the jitter can be suppressed to $4.2/N$ ns. We set N to 40 and the jitter before the FM control is reduced to 105 ps peak-to-peak. As a result, the FM control is relaxed and the influences on other components were eliminated. The maximum delay of the

master trigger is $190 \mu\text{s}$ ($=40 \cdot 2436/508.58$), where 2436 is the harmonic number of SPring-8. This delay time is much shorter than the period of the line frequency of 60 Hz and it does not make any problems. From the evaluation of the basic performance, the jitter between the SPring-8 bucket and the beam trigger of SACLA was obtained to be 3.3 ps std., which satisfied the required precision.

BEAM COMMISSIONING

We started beam commissioning for the injection from SACLA to the SPring-8 SR in October 2018. The machine study for the injection has been conducted about one shift (~ 8 hours) per month. At first, we generated a long bunch beam for injection and the SACLA linac was operated only for injection without XFEL. Since the SR itself was already well commissioned, the beam was easily stored by the SR after the transmission of electrons throughout XSBT. The injection efficiency of more than 90% was achieved in February 2019. We then began the injection in parallel with the XFEL operation. A short-bunch beam has been injected into the SR since then for easier operation together with XFEL and the CSR effect is not serious for current SPring-8 as described later. We succeeded in top-up operation in Fall 2019 with the rated beam current of 100 mA. The first user run with the injection from SACLA was performed in February 2020 and the primary injector was switched to SACLA from the original 8 GeV booster synchrotron and 1 GeV linac. The original injector was shut down in March 2021.

Beam Monitors

BPMs along XSBT are used for monitoring the beam orbit and for stabilization of the injection orbit and beam energy. Screen monitors are utilized for tuning the beam envelop. Figure 5 shows a comparison between the beam profiles from SACLA and the booster synchrotron. The beam size of SACLA is significantly smaller than the synchrotron. Current transformers are used as the beam charge monitor. The injection efficiency is evaluated by comparing the beam charge in the XSBT and the increase of the stored current monitored by a DCCT. The optical-fiber-based beam loss monitor is utilized for loss-less transmission. Figure 6 shows a typical event display of the loss monitor when some beam losses were detected. Beam losses were eliminated by tuning the optics of XSBT. The beam loss monitor detects Cherenkov radiation generated by lost electrons in an optical fiber along XSBT. The loss position is the beam energy and injection timing were adjusted according to the synchrotron oscillation detected by a single-pass BPM in the SR.

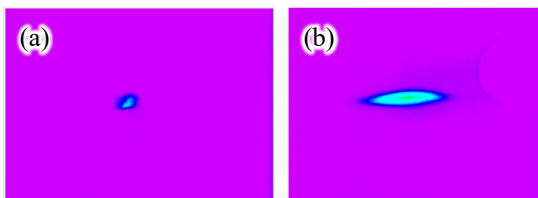

Figure 5: Beam profiles from SACLA (a) and the booster synchrotron (b).

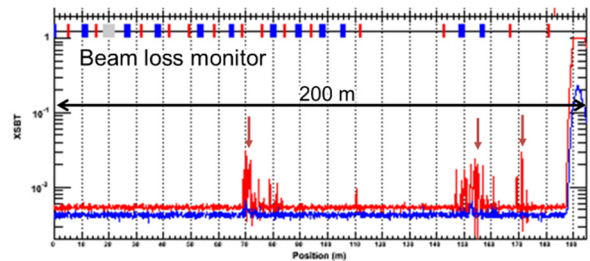

Figure 6: Event display of the beam loss monitor.

Stability

SPring-8 has been operated stably as before even after switching the injector to the SACLA linac. Figure 7 shows a typical trend graph of the stored current for 24 hours. The stored current is kept constant within 0.1% level by injecting a beam every about 50 seconds in this case. Although there are some drops of the stored current due to the trips of accelerator units in SACLA, the operation of SACLA is automatically resumed as soon as possible and the deficit of the stored current is minimized.

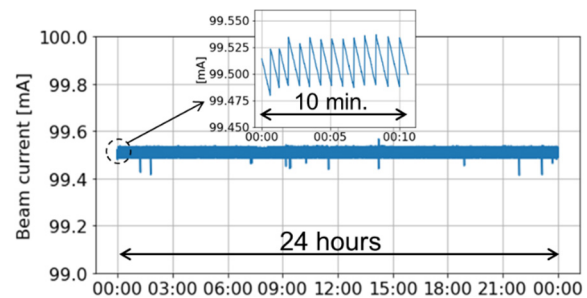

Figure 7: Trend graph of the stored current in SPring-8. A magnification for 10 minutes is also plotted.

Figure 8 shows a trend graph of the injection efficiency during top-up operation. The injection efficiency is approximately 90% throughout the operation. The gap of each undulator is closed in this case. Higher injection efficiency is obtained if every undulator gap is fully opened.

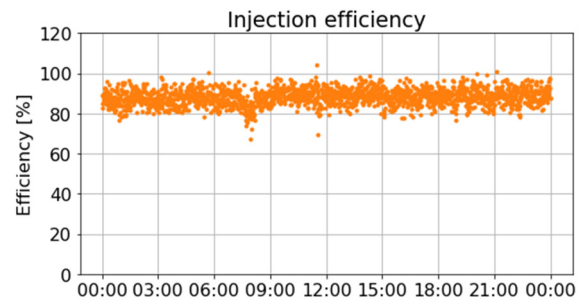

Figure 8: Trend graph of the injection efficiency.

Figure 9 shows a trend graph of the beam position at the end of XSBT. The beam orbit is stable enough for the current SPring-8. The beam position jitter is 0.14 mm std. for horizontal and 0.05 mm std. for vertical. The reason for the larger horizontal jitter is thought to be due to the CSR

Content from this work may be used under the terms of the CC BY 3.0 licence (© 2021). Any distribution of this work must maintain attribution to the author(s), title of the work, publisher, and DOI

effect in XSBT. This horizontal pointing jitter comes from the short bunch operation also for XSBT for easier operation with XFEL. If the bunch length for XSBT is longer, such a CSR effect would be minimized.

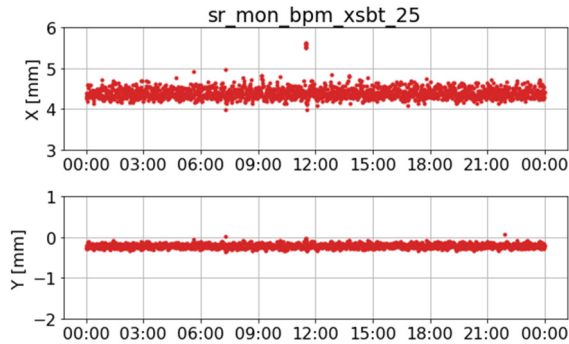

Figure 9: Trend graph of (a) horizontal and (b) vertical beam positions at the end of XSBT.

The injection from SACLA to SPring-8 is conducted together with XFEL operation of two beamlines, BL2 and BL3. The XFEL performances for the two beamlines are not degraded and stable XFEL radiation is delivered to users.

Bunch Purity

The bunch purity of the SPring-8 SR is important especially for time-resolved experiments. Satellite electrons from SALCA should be suppressed as small as possible. Therefore, the bunch purity is always monitored by a purity monitor [8].

During the injection from SACLA, a significant impurity more than the requirement of 10^{-8} compared to the main bunch was observed in the SR at the 9th bucket (~ 18 ns) after the main bunch. If we closed collimators and energy slits before the third bunch compressor (BC3) in SACLA, the impurity was significantly reduced. We thought that the satellite electrons came from the low-energy part of SACLA and investigated the reason for the impurity. We found backward electrons between the 476 MHz cavity and the L-band APS (alternating periodic structure) cavity, where the beam energy is approximately 1 MeV. We also confirmed the reflection from the entrance of the L-band APS cavity and the re-acceleration of backward electrons by the 476 MHz cavity with a 1D tracking simulation. Therefore, we installed a sweeper for the reflected electrons. The sweeper is a ~ 10 cm-long stripline kicker driven by a 3 kV high-voltage pulse generator. As a result, satellite electrons from this section were reduced by approximately one order of magnitude.

Even after these countermeasures to reduce satellite electrons, however, the impurity at address 9 was gradually increased during a long user run. Therefore, we installed a bunch purification system, a similar setup to a bunch-by-bunch feedback system to suppress a collective instability. The purification system excites a vertical betatron oscillation at a satellite bunch and the impure electrons are removed by a scraper in the SR, having a narrow gap of 5 mm.

Figure 10 shows a typical trend graph of the bunch purity at address 9 from a high-current main bunch. The bunch purification is applied approximately twice a day and the bunch purity is below 10^{-9} level.

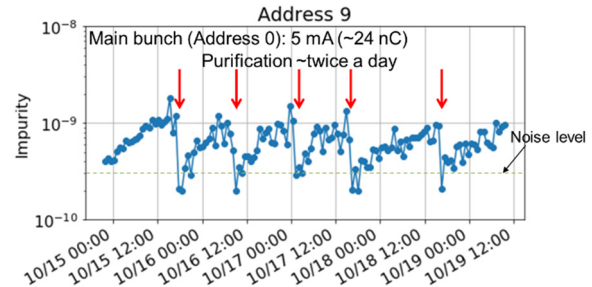

Figure 10: Trend graph of the bunch purity at address 9 after the main bunch of 5 mA. The noise level of the purity monitor is shown by the green dashed line. Red arrows indicate operations of the bunch purification.

SUMMARY

We proposed the SPring-8-II project, which is a low-emittance upgrade of SPring-8. Since a low-emittance electron beam is necessary for SPring-8-II due to a narrow dynamic aperture, the injector for SPring-8-II should be switched to SACLA, which can generate a small emittance beam enough for SPring-8-II. The injection from SACLA is also beneficial for the current SPring-8 since the energy consumption and the maintenance cost can be reduced by shutting down the original 8 GeV booster synchrotron and 1 GeV linac. We developed an on-demand switching system of beam route and parameters, and a precise synchronization system of SACLA to SPring-8 to inject an electron beam to SPring-8 in parallel with XFEL operation. The developed systems have been working well and both SPring-8 and SACLA have been stably operated. Although the degradation of the bunch purity was found at first, the impurity was reduced to the required level by removing satellite electrons in both SACLA and SPring-8. Thus, the beam injection from SACLA is almost ready for the coming upgrade of SPring-8. The precise timing synchronization system of SACLA also enables simultaneous usage of both XFEL from SACLA and X-rays from SPring-8, which has the potential to explore new science.

REFERENCES

- [1] “SPring-8-II Conceptual Design Report”, RIKEN SPring-8 Center, Hyogo, Japan, Nov. 2014.
- [2] C. Mitsuda *et al.*, “The Construction Status of Beam Transport Line From XFEL-Linac to SPring-8 Storage Ring”, in *Proc. 2nd Int. Particle Accelerator Conf. (IPAC’11)*, San Sebastián, Spain, Sep. 2011, paper THPC144, pp. 3224-3226.
- [3] T. Itoga *et al.*, “Present Status of the Cherenkov Beam Loss Monitor at SACLA”, in *Proc. 5th Int. Particle Accelerator Conf. (IPAC’14)*, Dresden, Germany, May 2014, pp. 1808–1810. doi:10.18429/JACoW-IPAC2014-TUPRI100
- [4] H. Maesaka *et al.*, “On-Demand Beam Route and RF Parameter Switching System for Time-Sharing of a Linac for X-ray Free-Electron Laser as an Injector to a 4th-Generation

Synchrotron Radiation Source”, in *Proc. 10th Particle Accelerator Conf. (IPAC'19)*, Melbourne, Australia, May 2019, pp. 3427–3430.

doi:10.18429/JACoW-IPAC2019-THYYPLS1

- [5] T. Hara *et al.*, “Time-interleaved multi-energy acceleration for an x-ray free-electron laser facility”, *Phys. Rev. ST Accel. Beams*, vol. 16, p. 080701, 2013.

doi:10.1103/PhysRevSTAB.16.080701

- [6] C. Kondo *et al.*, “A stable pulsed power supply for multi-beamline XFEL operations”, *Rev. Sci. Instrum.*, vol. 89, p. 064704, 2018. doi:10.1063/1.5025109

- [7] T. Ohshima *et al.*, “Timing Synchronization System for Beam Injection from the SACLA Linac to the SPring-8 Storage Ring”, in *Proc. 10th Particle Accelerator Conf. (IPAC'19)*, Melbourne, Australia, May 2019, pp. 3882–3885.

doi:10.18429/JACoW-IPAC2019-THPRB034

- [8] K. Tamura and T. Aoki, “Single Bunch Purity During Spring-8 Storage Ring Top-Up Operation”, in *Proc. 1st Annual Meeting of Particle Accelerator Society of Japan*, Funabashi, Japan, Aug. 2004, pp. 581-583.