

# MAGNETIC FIELD CALCULATION OF PLANAR SCUs USING ANSYS MAXWELL\*

Y. Shiroyanagi<sup>†</sup>, E. Anliker, Q. Hasse, H. Hu, M. Kasa, I. Kesgin, Y. Ivanyushenkov  
 Argonne National Laboratory, Lemont, USA

## Abstract

The Advanced Photon Source (APS) Upgrade includes a 4.8-m-long superconducting undulator (SCU) cryostat containing two 1.9-m-long, 16.5-mm-period planar NbTi undulator magnets. The magnetic and mechanical design of this magnet follows the design of the existing 1.1-m-long, 18-mm-period planar SCU that is currently in operation at the APS [1]. Although OPERA is a reliable standard software tool for magnetic field calculations, ANSYS Maxwell 3D has the advantage of calculating a large and complex geometry. In this paper, first, the magnetic field map, including the peak field and end fields, is benchmarked against the magnetic measurement data of the existing planar SCU18-1. Then, corrector current optimization is presented for the 1.5-m-long, 21-mm-period planar SCU. Finally, a magnetic field model of a full-scale, 1.9-m-long planar SCU is presented.

## INTRODUCTION

Although OPERA is a reliable standard software tool for magnetic field calculations, ANSYS Maxwell 3D has the advantage of calculating a large and complex geometry. Thus, the ANSYS Maxwell solver is used to calculate magnetic field of three long planar SCU's. The model includes end correction coils and the 1<sup>st</sup> and 2<sup>nd</sup> integrals of the field. The model is benchmarked with the existing SCU18-1 field measurements. Then, the model is applied first to a 21-mm-period, 1.5-m-long SCU for corrector current optimization and then to a 16.5-mm-period, 1.9-m-long SCU to see the limit of the geometry that the Maxwell solver can handle.

## METHOD

The ANSYS Maxwell solver is used for both 2D and 3D models. First, one period model with the periodic boundary condition is built and the peak field is calculated. Then the model is extended to multiple period lengths. In that case, an open boundary condition is used at the end sections.

### SCU18-1 (18-mm Period, 9.5-mm Gap, 1.1-m Long)

SCU18-1 is currently in operation and magnetic measurement results were published and available [1]. A 3D magnetic model was made with corrector coils at the ends. Figure 1 shows the 3D model geometry and the boundary conditions of the SCU 18-1 model as built. Steel 1008 is used for the core material, and copper is used as a

conductor. The model contains 120 poles and 119 winding grooves. The main winding contains 53 turns at each groove. In the two end grooves, the number of conductor turns is reduced to 15 and 38, respectively. The 1<sup>st</sup> and 2<sup>nd</sup> 15-turn corrector coils are wound on top of the main coil as shown in Fig. 1. A 2D model is also built using the same configuration.

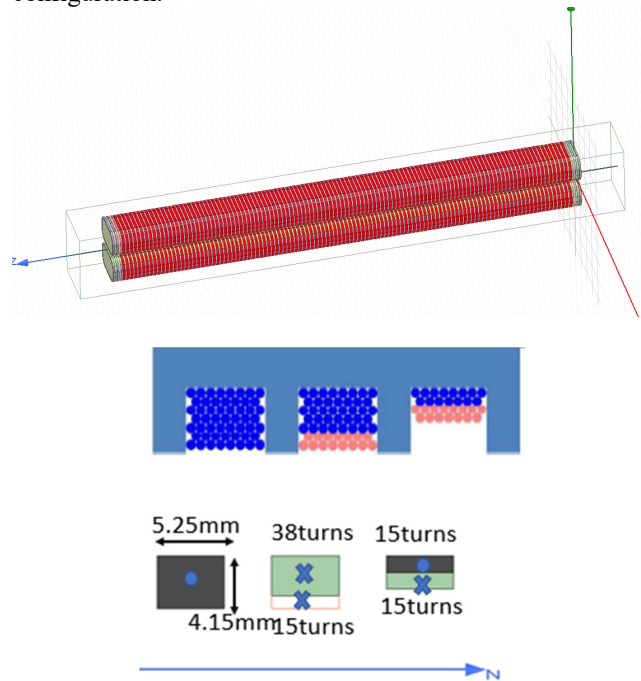

Figure 1: (top) The overall geometry of the 3D model. (middle) The actual winding scheme of the SCU18-1 correctors [1]. (bottom) A cross section of the 3D model at the ends. Each groove has 53 turns of conductor, reduced to 38 and 15 turns in the end grooves. The corrector coils are 15 turns each wound on the main.

To confirm the accuracy of the 2D and 3D model calculations, one set of the main and the corrector currents, which is 450 A for the main and 48 A for the 1<sup>st</sup> and 2<sup>nd</sup> correctors, is compared with the actual measured fields. In Fig. 2, measured vertical magnetic field and calculated field using 3D and 2D model are plotted along the same z axis (beam direction). Figure 3 shows the end section of the same field profiles. The calculated peak field 0.94 T (9400 G) is lower than the measured peak field, 0.976 T (9760 G) [1]. This is consistent with one period model with a periodic boundary condition.

\* Work supported by U.S. Department of Energy, Office of Science, under Contract No. DE-AC02-06CH11357.

<sup>†</sup> yshiroyanagi@anl.gov

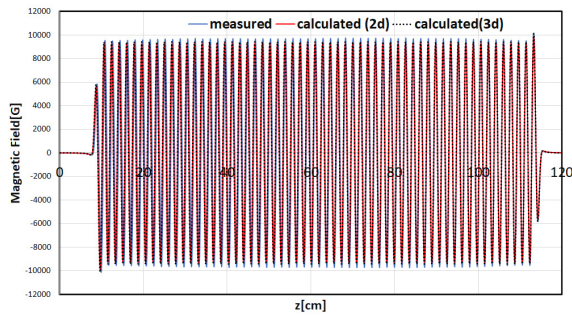

Figure 2: The on-axis field comparison between measured and calculated fields in 2D and 3D models. The main current is 450 A and corrector currents are 48 A each.

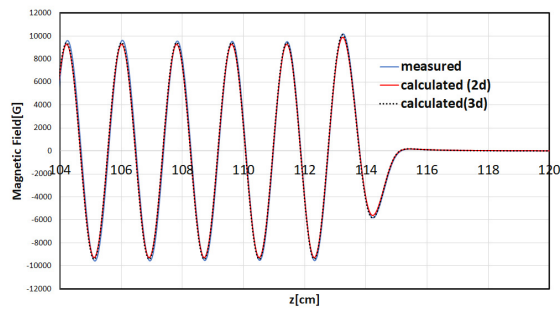

Figure 3: Comparison of measured and calculated end field for the main current of 450 A, and the 1<sup>st</sup> and 2<sup>nd</sup> corrector currents of 48 A.

Figure 4 includes the calculated and measured field integrals for the same case. The calculated 1<sup>st</sup> integral is 24.1 G cm, and the 2<sup>nd</sup> integral is 20500 G cm<sup>2</sup>. Measured 1<sup>st</sup> integral is 44.56 G cm, and the 2<sup>nd</sup> integral is 20812.3 G cm<sup>2</sup>. These numbers are very close.

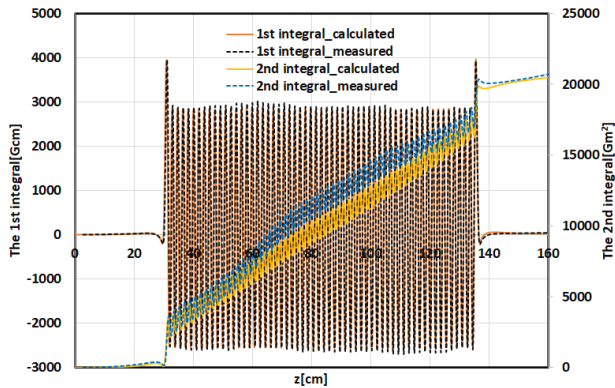

Figure 4: SCU18-1 measured 1<sup>st</sup> and 2<sup>nd</sup> integrals for the same case (450 A as a main current and 48 A for 1<sup>st</sup> and 2<sup>nd</sup> correctors) are shown as well as the calculated ones using the 3D model.

### LCLS-SCU (21-mm Period, 8-mm Gap, 1.5-m Long) Corrector Current Optimization Example

Field integrals can be optimized by changing the end correction currents. The 2D optimizer is used to determine optimal correction current quickly; then for further optimization the 3D model is used. A 21-mm-period, 8-mm-gap 1.5-m-long SCU is chosen for the correction current

optimization example. The main current is 588 A, and the calculated peak field is 1.61 T, which matches well with the measured peak field of 1.66 T [2].

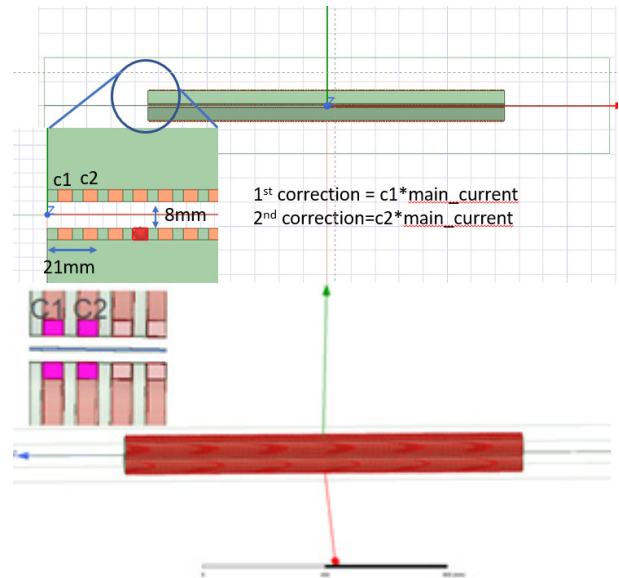

Figure 5: (top) A 2D model of a 21-mm-period, 8-mm-gap SCU used for optimizing end correction. (bottom) The 3D model of the same undulator with the 1<sup>st</sup> and 2<sup>nd</sup> correction currents.

The 1<sup>st</sup> corrector current is  $C1 \times \text{main current}$ , and the 2<sup>nd</sup> corrector current is  $C2 \times \text{main current}$ . The geometry and the end section of the 2D model are shown in Fig. 5 (top). Figure 5 (bottom) shows the 3D model of the same undulator. The parameters  $C1$  and  $C2$  were determined by minimizing the 1<sup>st</sup> and 2<sup>nd</sup> integrals. The 2D Maxwell optimizer was used to determine the correction parameters, shown in Fig. 6, by varying  $C1$  and  $C2$  between 0 and 1. Figure 6 shows the 2<sup>nd</sup> integrals when  $C1 = 0-1$  and  $C2 = 0-1$ .

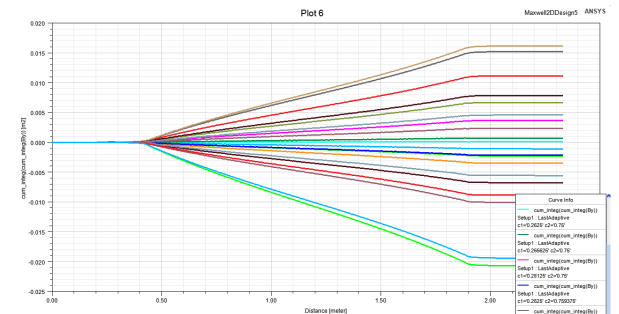

Figure 6: The 2<sup>nd</sup> field integrals calculated by the 2D optimizer with both  $C1$  and  $C2$  as variables,  $C1 = 0-1$  and  $C2 = 0-1$ .

Based on 2D optimization, the optimal values are  $C1 = 0.262$  and  $C2 = 0.75$ , which are close to the measured  $C1 = 0.25$  and  $C2 = 0.75$  [3]. This means that the optimizer is working properly. Based on these parameters, field integrals calculated with the 3D model were then minimized by varying  $C1$  from 0.262 to 0.2632 and keeping

Content from this work may be used under the terms of the CC BY 3.0 licence (© 2021). Any distribution of this work must maintain attribution to the author(s), title of the work, publisher, and DOI

$C2 = 0.75$ . The predicted parameters  $C1$  and  $C2$  from 2D model are close to the ones calculated with the 3D model.

Figure 7 shows the calculated 2<sup>nd</sup> integral based on the 3D model with  $C2 = 0.75$  when  $C1$  varies to minimize the 2<sup>nd</sup> integral. The optimal 2<sup>nd</sup> integral (with  $C1 = 0.262$ ) based on the 2D model is plotted as well. The slightly different optimal value for the 3D model is  $C1 = 0.26311$ , which yields a 2<sup>nd</sup> integral of  $-816 \text{ G cm}^2$ . Since there are 15 turns of the main and 15 turns of the 1<sup>st</sup> corrector,  $C1 = 0.262$  corresponds to

$$(15 \times 588 \text{ A} - 0.262 \times 53 \times 588 \text{ A}) / 15 = 43.67 \text{ A}$$

and  $C1 = 0.26311$  corresponds to

$$(15 \times 588 \text{ A} - 0.26311 \times 53 \times 588 \text{ A}) / 15 = 41.36 \text{ A}.$$

Thus, the difference between calculated correction currents is 2.3 A, which is reasonable.  $C2 = 0.75$  corresponds to  $(0.75 \times 53 \times 588 \text{ A} - 38 \times 588 \text{ A}) / 15 = 68.6 \text{ A}$ .

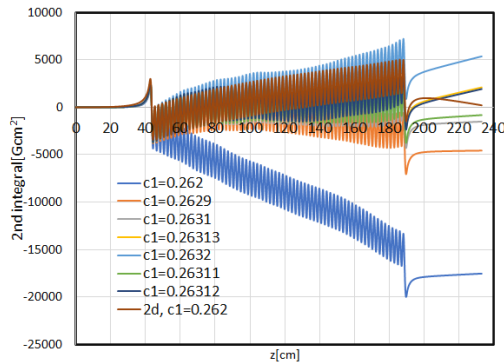

Figure 7: The 2<sup>nd</sup> integral ( $\text{G cm}^2$ ) at  $C1 = 0.262$  to  $0.2632$  based on the 3D model and optimal case from the 2D model ( $C1 = 0.262$ ,  $C2 = 0.75$ ).

## APSU-SCU (16.5-mm Period, 8-mm Gap, 1.9-m Long)

Currently a 16.5-mm-period, 8-mm-gap, 1.9-m-long, 232-pole planar SCU is being fabricated. The 3D model for this SCU is also built and the magnetic field is calculated. Each winding groove has 53 turns, and the end turns are reduced to 38 turns and 15 turns. Figure 8 (top) shows the model geometry of the two SCUs in series. The corrector winding contains 15 conductor turns at the 1<sup>st</sup> and 2<sup>nd</sup> grooves, which is the same as the SCU18-1. Figure 8 (middle, bottom) are the field maps for the two 1.9-m-long SCUs in series without corrector current. The center peak field is calculated to be 1.04 T for a current of 450 A, which is the same value as the one-period model with a periodic boundary condition. The calculated 2<sup>nd</sup> integral for two SCUs is  $-0.01207 \text{ T m}^2$  ( $-1207 \text{ kG cm}^2$ ), which is twice as much as  $-0.006 \text{ T m}^2$  ( $-600 \text{ kG cm}^2$ ) of a single SCU. For example (not optimized), when 45 A of the 1<sup>st</sup> correction and 2<sup>nd</sup> correction current is applied, the 2<sup>nd</sup> integral of the single SCU is reduced to  $9.13 \times 10^{-5} \text{ T m}^2$  ( $9.13 \text{ kG cm}^2$ ). The next step is an optimization of the correction current. It should be noted that the Maxwell solver successfully handled the two 1.9-m-long SCU geometries.

## CONCLUSION

Magnetic modeling using ANSYS Maxwell has reasonable accuracy, and its optimizers are reliable. It can also handle a large geometry. Therefore, it is useful for future SCU development.

## ACKNOWLEDGEMENTS

First author acknowledges Q. Maofei for useful discussion on SCU corrector current optimizations.

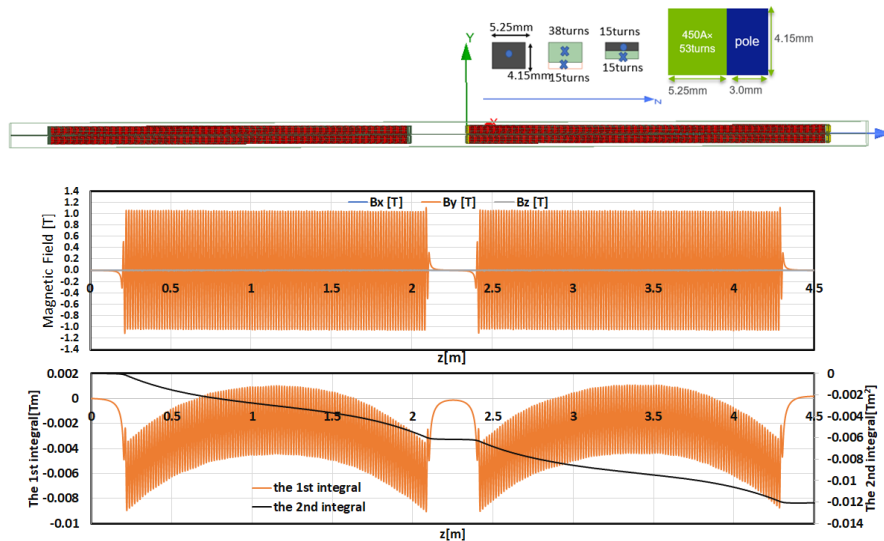

Figure 8: (top) The model geometry of the two SCUs in series. (middle, bottom) The calculated magnetic fields of two 1.9-m-long, 16.5-mm-period SCUs in series with no correction. The peak field is 1.04 T for 450 A. The calculated 2<sup>nd</sup> integral based on this field is  $-0.01207 \text{ T m}^2$  ( $-1207 \text{ kG cm}^2$ ), which is twice as much as a single SCU.

## REFERENCES

- [1] Y. Ivanyushenkov *et al.*, “Development and operating experience of a 1.1-m-long superconducting undulator at the Advanced Photon Source”, *Phys. Rev. Accel. Beams*, vol. 20, p. 100701, 2017. doi:10.1103/PhysRevAccelBeams.20.100701
- [2] P. Emma *et al.*, “A plan for the development of superconducting undulator prototypes for LCLS-II and future FELs”, in *Proc. 36th Int. Free Electron Laser Conf. (FEL2014)*, Basel, Switzerland, Aug. 2014, paper THA03, pp. 649-653.
- [3] C. L. Doose, M. Kasa, and S. H. Kim, “End-Field Analysis and Implementation of Correction Coils for a Short-Period NbTi Superconducting Undulator”, in *Proc. 24th Particle Accelerator Conf. (PAC'11)*, New York, NY, USA, Mar.-Apr. 2011, paper TUP241, pp. 1280-1282.