

# ACCELERATOR CHALLENGES OF THE LHEC PROJECT\*

B. J. Holzer<sup>†</sup>, K. D. J. André, O. S. Brüning, CERN, Geneva, Switzerland  
M. Klein, Liverpool University, Liverpool, UK  
S. A. Bogacz, JLab, Newport News, USA

## Abstract

The LHeC project studies the design of a future electron-proton collider at CERN that will run in parallel to the standard LHC operation. For this purpose, the existing LHC storage ring is considered to be combined with an Energy Recovery Linac (ERL), that will accelerate electrons up to a kinetic energy of 50 GeV. This concept might also be applied to the FCC-eh, where even larger centre of mass energies are obtained. The peak luminosity of  $1 \times 10^{34} \text{ cm}^{-2} \text{ s}^{-1}$  requires a sophisticated design of the RF structures, linacs, arcs and interaction lattices. For achieving highest luminosity and performance, the electrons are accelerated such that, after the interaction point, their energy is recovered through the same RF structures. While this energy recovery concept is a very promising approach, and will be investigated at the PERLE test facility, severe challenges are set by the layout of the interaction region, the beam separation concept and the design of the linac and arc lattice for highest possible momentum acceptance. The control of the emittance and beam-beam effect of both, electron and proton beams, has been studied in front-to-end simulations and will be presented. We summarise the design principles of the ERL, the optimisation of the lattice and the main parameters of the project.

## INTRODUCTION

The LHeC project studies the design of an intense, high energy electron beam to collide with the protons of the LHC storage ring and aims for an integrated luminosity of about  $5 \text{ ab}^{-1}$ . The design of the machine is described in detail in the updated version of the LHeC design report [1]. It is based on two super-conducting linacs of about 900 m length, which are placed opposite to each other and connected by three return arcs on both sides (Fig. 1). A final electron beam energy of 50 GeV is reached in this 3-turn racetrack ERL design. The concept allows to keep the overall energy consumption on a modest level for up to 20 mA electron current. The main parameter list is shown in Table 1.

## LINAC AND RF SYSTEM

The option to design a particle collider as Energy Recovery Linac, provides the opportunity to overcome or avoid a number of limitations of circular machines. Still, the price to pay occurs in form of a number of challenges, that come along with the ERL design. In order to reach the luminosity of  $1 \times 10^{34} \text{ cm}^{-2} \text{ s}^{-1}$  with an electron energy of 50 GeV, the

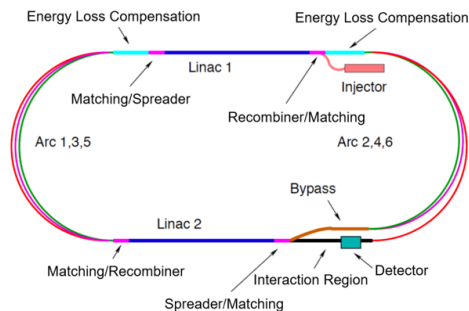

Figure 1: ERL geometry, using two sc. linear accelerators, connected by return arcs.

Table 1: ERL Main Parameters

Parameter	Unit	Value
Beam energy	GeV	50
Bunch charge	pC	499
Bunch spacing	ns	24.95
Electron current	mA	20
trans. norm. emittance	$\mu\text{m}$	30
RF frequency	MHz	801.58
Acceleration gradient	MV/m	20.06
Total length	m	6665

concept of an ERL offers the advantage of a high brightness beam, high beam currents with limited synchrotron radiation losses and it avoids limitations due to the beam-beam effect - a major performance limitation in many circular lepton colliders (e.g. LEP). On the other side, the current of the ERL as well as the emittance are limited by its source: An operational goal of  $I_e = 20 \text{ mA}$  for the LHeC has been set, corresponding to a bunch charge of 500 pC at a bunch frequency of 40 MHz. Given three turns for the acceleration and deceleration, an overall current of 120 mA will be circulating in the ERL with impacts on the RF design, facing a virtual beam power of 1 GW. In order to limit RF losses, a superconducting (s.c.) RF system is foreseen with a required quality factor above  $Q = 10^{10}$ . In collaboration with JLab [2] prototypes have been developed: Figure 2 shows the Q-value which lies comfortably above this value up to the required acceleration gradient. The validation of these design concepts and the optimisation of the ERL performance in terms of source brightness and stable and efficient operation in the PERLE facility [3] is a key milestone for the LHeC design.

## RETURN ARCS AND SPREADERS

Special care has to be taken in the design of the ERL lattice: The optics of the three return arcs has to be opti-

\* Work supported by the U.S. DOE under contracts DE-AC05-06OR23177 and DE-SC0012704.

<sup>†</sup> for the LHeC and FCC-eh study group

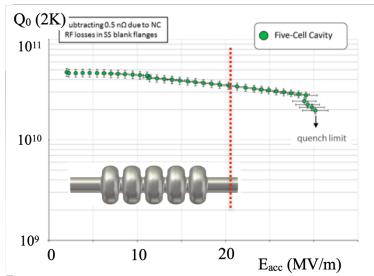

Figure 2: Q-parameter of the 5 cell cavity prototype.

mised for the different challenges, that come along with the increasing beam energy [4]. At low energy, a flexible momentum compaction lattice will allow optimisation of the bunch length: An isochronous beam optics has been chosen for arc 1,2,3 to allow short bunches. At higher energies, in arc 4,5,6 an efficient emittance control is needed, as the effects of the emitted synchrotron light will take over. These arcs therefore are equipped with a theoretical minimum emittance optics (TME) to mitigate the emittance blow up (see Fig. 3). The focusing structure of the linacs has to provide focusing for the complete energy range of the accelerating / decelerating beams. Here a FoDo structure has been chosen with a phase advance of  $130^\circ$  per cell. Different cell lengths have been investigated and simulation studies showed - not unexpectedly - an increasing performance for a shorter cell length. In Fig. 4 the beta-beat of the different optics is shown throughout the linac structures with best performance provided by the highest density of individual quadrupoles along the lattice. At the end of the Linac, the beam has to be guided into the return arc that corresponds to the beam rigidity at the given acceleration step. A combination of dipoles and quadrupole magnets provides the vertical bending and adapts the beam optics to the arc structure. This “spreader” (in front) and “re-combiner” (after the arc) represent a non-dispersive deflecting system to provide the necessary vertical off-set between the three arc modules and limit at the same time the detrimental effect on the vertical beam emittance.

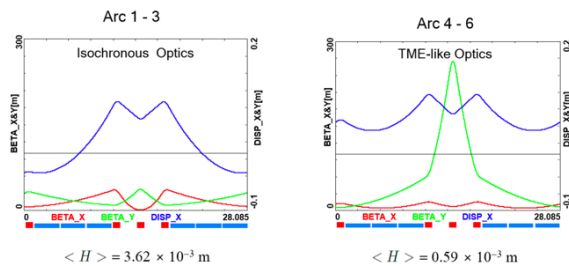

Figure 3: Basic FMC cells of the ERL arcs: Isochronous (left) for arc 1,2,3 and TME lattice (right) for arc 4,5,6.

## INTERACTION REGION

The interaction region between the electron beam of the ERL and the proton beam of the LHC is one of the most challenging parts of the design, as several aspects have to be considered at the same time. The required luminosity of the LHeC requests beta functions in the order of 10 cm at

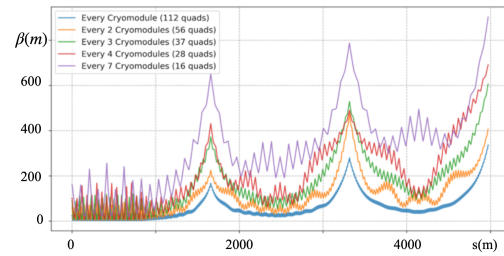

Figure 4:  $\beta$  function along the linac for different cell lengths. With increasing number of quadrupoles the energy dependent *beta*-beat reduces considerably.

the Interaction point with equal beam sizes at the IP in both transverse planes:  $\sigma_{xe} = \sigma_{xp}$ ,  $\sigma_{ye} = \sigma_{yp}$ . Given the considerable difference of the beam energies, the electrons and protons have to be focused independently and at the same time an efficient beam separation scheme has to separate the electron beam after the collision from the protons. Finally and as condition sine-qua-non, the emittance blow up due to the beam-beam effect has to be well controlled to allow for a successful energy recovery during the decelerating part of the ERL process. In Fig. 5 the principle layout of the IR is shown schematically. The requirements of small beam size and efficient separation are fulfilled by combining the spectrometer dipole of the high energy physics detector and the electron mini-beta quadrupoles (being off-center with respect to the electrons) to create a quasi constant separation field from the IP until the location of the first sc. proton quadrupole “QA1” at a position of  $L^* = 15$  m. At the same time, the electron quadrupoles provide an early focusing to limit the electron beam size, and accordingly the separation needed at the position of the first proton magnet, designed as half quadrupole, to reduce further the need for beam separation as much as possible and limit the critical energy of the emitted synchrotron light. The transverse offset of the electron quadrupoles has been chosen to obtain the same effective dipole field as the spectrometer dipole. Figure 6 summarises the optimisation process that compares the emitted light for a simple dipole based separation scheme with the different optimisation steps. For more details see [5].

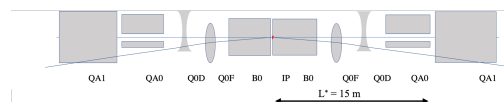

Figure 5: Schematic layout of the IR region with the electron mini-beta quadrupoles acting as combined function magnets to separate the beams.

The optics of the colliding proton beam follows the standard settings of the HL-LHC: Fig. 7 shows the proton optics at the interaction point of the LHeC. The long-ranging beta-beat which is an essential feature of the so-called ATS optics [6] is clearly visible on both sides of the IP.

## EMITTANCE & BEAM-BEAM EFFECT

Control of the beam emittance is required for the complete ERL design. Unlike electron rings, where an equilibrium

Content from this work may be used under the terms of the CC BY 3.0 licence (© 2021). Any distribution of this work must maintain attribution to the author(s), title of the work, publisher, and DOI

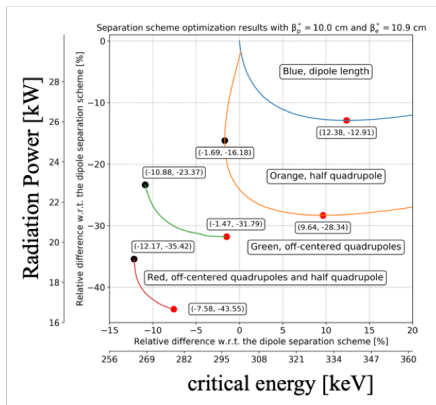

Figure 6: Optimisation of the synchrotron light, emitted in different scenarios of the beam separation scheme.

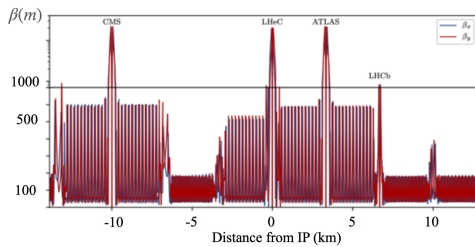

Figure 7: Proton optics for matched beam conditions with the electrons at the IP of LHeC.

emittance is obtained after a number of damping times, the choice of an ERL means careful control of all effects that could affect the beam size. The arc design already fulfills this condition by dedicated choice of the lattice cells, “FMC” or “TME”. Spreaders and combiners are optimised for smallest impact on the vertical emittance, choosing an achromatic deflection scheme. Most prominent of all emittance effects however is the beam-beam effect or - in the language of linear colliders - the beam disruption. Here the main advantage of the ERL concept is visible: While in a storage ring the beam-beam effect has to be limited, the beam-beam effect in the ERL can be pushed to higher limits, allowing higher luminosities. Still, the effect of the beam disruption on the emittance and so on the energy recovery performance has to be taken into account. In Table 2 the beam-beam tune shifts in different machines are compared with the design value of LHeC. The optics of the electron IR has been optimised to take the beam disruption into account and - profiting from the additional focusing effect between protons and electrons - increase the theoretically achievable luminosity. In Fig. 8 the electron beam size in the IR is shown, including the bb-effect. The uncompensated case shows a strong detrimental effect that leads to blow up of the emittance. The green curve shows a rematched optics that leads once more to a symmetric situation and adopts the beta functions to the periodic lattice structure of the arc: A prerequisite for a loss free energy recovery.

The phase space plots in Fig. 9 visualise the situation once more: the beam disruption leads to strong tails in the transverse beam profile, far beyond the theoretical emittance

ellipse (dashed line). Re-optimising the optics to take the beam disruption into account allowed us to find an optimum between the quest for highest luminosity and safe beam deceleration (solid line).

Table 2: Beam Beam Effects in LEP, LHC and LHeC

Parameter	LEP	LHC	LHeC
Beam size $\sigma_{x/y}$ ( $\mu\text{m}$ )	180 / 7	16.6 / 16.6	5.8
Energy (GeV)	100	7000	50
$\beta_x^* / \beta_y^*$ (cm)	125 / 5	55 / 55	10 / 10
Bunch intensity ( $10^9$ )	400	120	3.1
Beam Beam param.	0.07	0.0037	0.99
Beam disruption			14.5

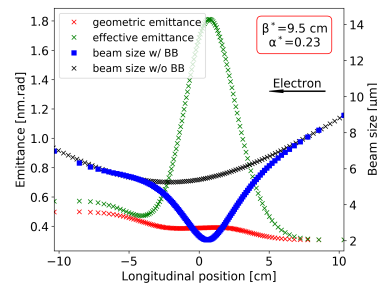

Figure 8: Matching of the electron optics, including the disruption effect: The beam size calculated with bb disruption (blue) is re-matched to the theoretical optics (black).

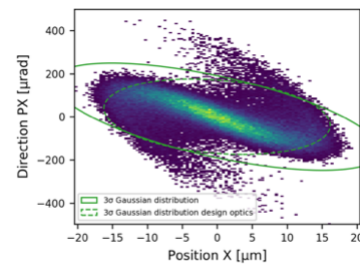

Figure 9: Phase space plot of the electrons at the IP: The development of tails under the influence of the beam-beam effect has to be controlled by a careful rematch of the optics.

## CONCLUSION

The optics and lattice of the LHeC project have been designed for smallest emittance. Linacs, arcs and spreaders were optimised to limit the effects of synchrotron radiation and a careful design of the interaction region mitigates beam disruption. These are pre-requisites for a successful energy recovery performance especially during the decelerating branch of the ERL, where the emittance of the beam increases and any detrimental effect of the beam quality has to be avoided or limited as much as possible. In front-to-end simulations the full performance of the ERL has been studied and based on the optimised layout, values of the energy recovery performance of up to 98% have been reached. Details are summarised in [7] in these proceedings.

## REFERENCES

- [1] O. Bruning and M. Klien, “The Large Hadron-Electron Collider at the HL-LHC”, CERN, Geneva, Switzerland, Rep. CERN-ACC-Note-2020-0002, Jan. 2020.
- [2] F. Marhauser, “Recent results on a multi-cell 802 Mhz bulk Nb cavity”, presented at 4th Annual Meeting of the Future Circular Collider Study (FCC Week 2018), Amsterdam, Netherlands, Apr. 2018, unpublished.
- [3] M. Klein and A. Stocchi, “PERLE: A High Power Energy Recovery Facility for Europe A Contribution to the Update of the European Strategy on Particle Physics”, CERN, Geneva, Switzerland, Rep. CERN-ACC-NOTE-2018-0086, Dec. 2018.
- [4] D. Pellegrini, A. Latina, D. Schulte, and S. A. Bogacz, “Beam-dynamics Driven Design of the LHeC Energy Recovery Linac”, *Physical Review Special Topics - Accelerators and Beams*, vol. 18, no. 12, Dec. 2015.  
doi:10.1103/physrevstab.18.121004
- [5] B. J. Holzer and K. D. J. André, “Energy Frontier DIS at CERN: the LHeC and the FCC-eh”, in *Proc. 40th Int Conf on High Energy physics - PoS(ICHEP2020)*, Prague, Czech Republic, Jul.-Aug. 2020, vol. 390, p. 687.  
doi:10.22323/1.390.0687
- [6] I. Bejar Alonso *et al.*, “High-Luminosity Large Hadron Collider (HL-LHC): Technical Design Report”, CERN, Geneva, Switzerland, Rep. CERN-2020-010, 2020.
- [7] K. D. J. A and B. J. Holzer, “Front-to-End Simulations of the LHeC Energy Recovery Linac”, presented at the 12th Int. Particle Accelerator Conf. (IPAC’21), Campinas, Brazil, May 2021, paper WEPAB064, this conference.