

# TRASCO RFQ

A.Pisent, M. Comunian, A. Palmieri, INFN-LNL, Italy  
G.V. Lamanna, INFN-Bari, Italy, D. Barni. INFN-Milano, Italy.

## Abstract

In this paper we report about a 5 MeV 30 mA RFQ, with 100% duty cycle, first step of an ADS, studied within the Italian project named TRASCO. The operating frequency is 352 MHz, as in similar accelerators, but the relatively lower current allows different design choices, like the use of a single klystron. The main outcome of eigenmode and thermal simulations will be reported. Other construction details, like the use of power coupling loops, will be described. The construction of a technological model, corresponding to the first third of the structure, will be completed next year.

## 1 INTRODUCTION

At LNL is under study an RFQ (Radio Frequency Quadrupole), first step of a high intensity proton linac to be used in an ADS (Accelerator Driven System) [1]. The construction of the first part of this proton linac is foreseen for the development of the Labs, as the primary linac of an ISOL facility, and as a demonstration of the front end of a high intensity machine for neutron spallation.

In table I the main RFQ parameters are listed. In particular the beam loading is less than  $\frac{1}{4}$  of LEDA [2], and this makes possible (and necessary) a different optimization of the design [3]. For example, we can use a single klystron and keep a lower power dissipation density in the cavity. The schematic layout of the RFQ is shown in Fig. 1; a technological model, corresponding to the first third of the RFQ, is under development in collaboration with the Italian company CINEL s.r.l and will be completed next year.

Table 1 RFQ parameters

Energy range	0.08-5	MeV
Frequency	352.2	MHz
proton current	30	mA
Duty factor	100	%
Maximum surface field	33	MV/m (1.8 Kilp.)
Emittance T RMS in/out	0.2/0.2	mm mrad norm.
Emittance L RMS	0.18	MeV deg
RFQ length	7.13	m (8.4 $\lambda$ )
Intervane Voltage	68	kV
Transmission	96	%
Modulation	1-1.94	
Average aperture $R_0$	0.29-0.32	cm
Synchronous phase	-90 $\pm$ -29	deg
Dissipated power SF*1.2	0.579	MW
Quality factor (SF/1.2)	8261	
Beam loading	0.1476	MW
RF power	0.726	MW

## 2 THE RESONATOR

The resonator, of four vanes kind, is divided in three segments, resonantly coupled. The operating frequency is 2 MHz distant respect to the closest quadrupole modes, and the dipole modes are outside the range of the main quadrupole band [3]. The design has been carried out using 2-D and 3-D computer simulations (SUPERFISH [4] and MAFIA).

The first kind of analysis has been used for example to calculate the inductance compensation as the average aperture  $R_0$  increases along the RFQ. This increase causes a capacitance reduction, since we mill the modulation with a single tool with transverse radius  $\rho=2.93$  mm (Fig. 2). Moreover SF gives good estimates of power dissipation and frequency shifts due to boundary deformations (Slater coefficients).

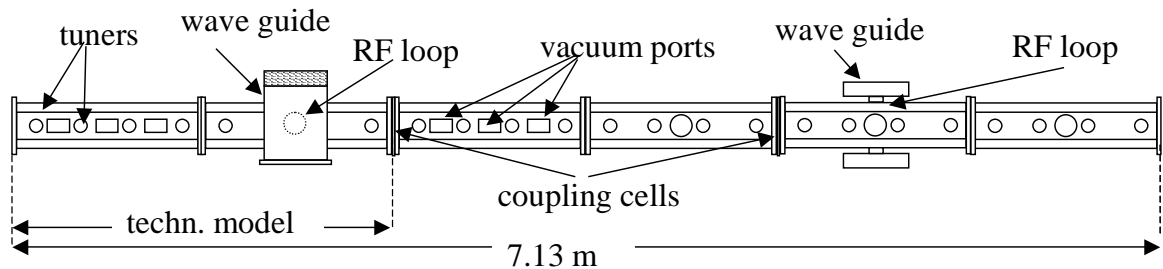

Fig.1 Schematic lay out of TRASCO RFQ (45° view).

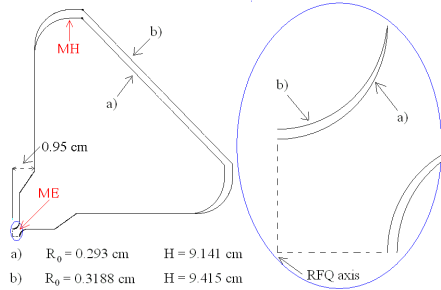

Figure 2: Transverse section for the minimum (a) and the maximum (b)  $R_0$  values are shown. ME and MH are the points where electric field and magnetic field are maximum.

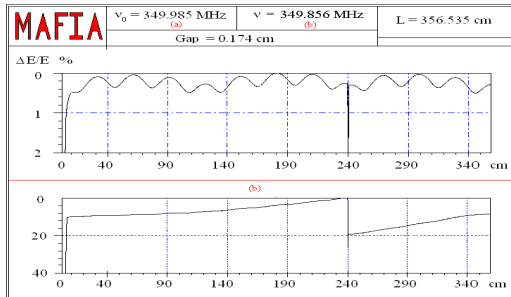

Fig. 3: Electric field between electrodes along half RFQ: tuned and detuned.

MAFIA simulations have been used to model accurately the RFQ details intrinsically 3D (end-cell, coupling-cell, tuners, vacuum ports grids....) and in few global runs so to compare the RF field distribution with transmission line calculations and bead pull measurements on the aluminium model [5].

Fig. 3 shows X component of the electric field along the RFQ (Y component follows the same behaviour) at the transverse position between the pole tips where the electric field is maximum. With half of the RFQ length and one quarter of the cross section we can simulate all the quadrupole and dipole modes on the same mesh (up to 1.7 M mesh points, 147 hours CPU). The field variation for perfect tuning shows the tuner positions ( $\Delta E/E \approx 0.6\%$ ). In case of local detuning, like for a missing tuner (the last on the right, near the middle of RFQ in Fig. 3b) the field is tilted, following the shape of the two closest quadrupole modes. The big field variation,  $\Delta E/E \approx 20\%$ , is related to the frequency shift  $\Delta v = -129$  KHz. We verified that a local frequency variation of about 20 kHz corresponds to the  $\Delta E/E \approx 2\%$  necessary for the nominal beam transmission.

Moreover we evaluated the power dissipation in the end-cell, coupling-cell and on the tuners. As a preliminary step we compared the power dissipation along the RFQ calculated with Superfish and MAFIA (Fig.4) the slight difference between the curves is due to the smaller mesh accuracy of Mafia simulation.

As an example power dissipation on coupling cell electrode and on the washer is shown in Fig. 5. About  $P \approx 1.4$  kW is dissipated on the washer. Observe that dissipation is non realistic where a sharp edge exists.

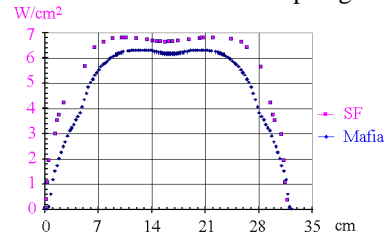

Fig. 4: Power dissipation along the profile (MAFIA and SF).

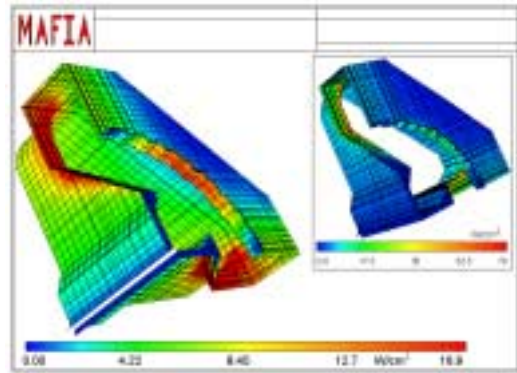

Fig. 5: Power dissipation in the coupling region.

### 3 THERMAL ANALYSIS

The thermal behavior of the RFQ cross section has been analyzed using the codes ANSYS and SF. The RF power source used is 1.5 times the SF distribution, for a total of about 1 kW per structure cm: 20% margin is due to the lower Q of the real structure, while the possibility to work with 10% higher voltage is kept open.

The mechanical deformation, calculated by ANSYS for the given cooling channels distribution, determines the (local) frequency shift by means of Slater theorem. The heat exchange between water and copper is calculated for the given water velocity ( $< 4$  m/s as a design parameter) and channel shape.

The goal is to keep below 20 kHz (threshold for acceptable field variation) the local frequency shift between RF on and RF off, and between the beginning and the end of a segment (water input and output). The first requirement guarantees that the tuners position, determined at low RF level, is still valid in operation; the second avoids field bumps due to the water temperature rise along the channels.

In fig. 6, we plot the temperature maps and the deformation maps at begin (left) and at the end (right) of one RFQ section; both (all shifts are below 20 kHz) the requirements have been fulfilled.

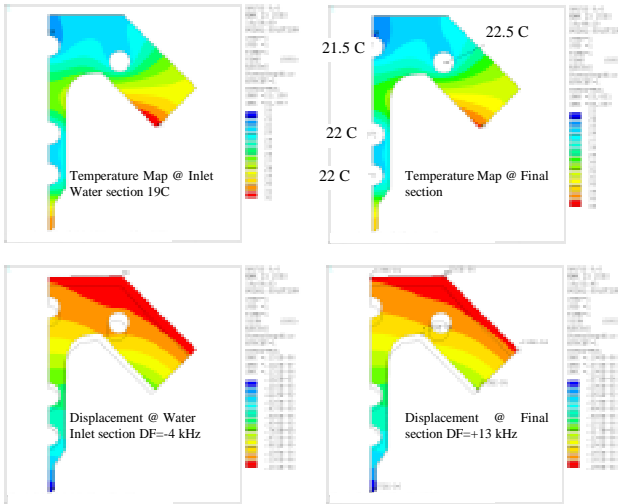

Fig. 6: Top: temperature maps at begin (left) and at the end (right) of one RFQ section. Bottom: deformation maps and frequency shifts.

#### 4 THE POWER COUPLER

The RFQ is fed via four power couplers (one per quadrant and in two different longitudinal positions). Each power coupler consists of a waveguide to coaxial “doorknob” transition, a RF ceramic window (LEP kind) and a drive loop (Fig.1). LEP NC cavity experience has shown for this geometry a good multipacting behavior [6].

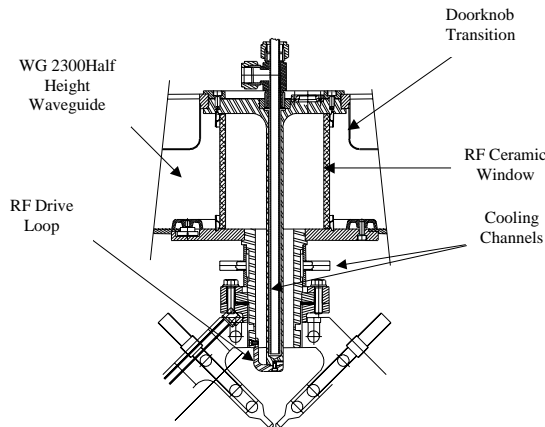

Fig.7 Scheme of principle of the coupler.

Our nominal RF level per coupler is 181 kW, somewhat higher than demonstrated with LEP windows [6,7]; the coupler performances together with the Q of the RFQ can be tested at CERN. The option to split again the power and to use eight couplers is still open.

For our purpose, we use a WR 2300 half-height rectangular waveguide in aluminum, while the 50  $\Omega$  coaxial transmission line has an inner radius of 8.7 mm and an outer radius of 20 mm. The waveguide to coax transition has been simulated with HFSS (High Frequency Structure Simulator) with the purpose to find the value of h (doorknob height) that allows the maximum transmission  $S_{12}$  from the waveguide to the coax. The results of these simulations are shown in Figs. 8 and 9.

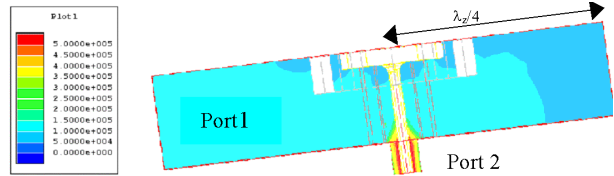

Fig. 8: Electric field magnitude [V/m] in the transmission for an input power of 250 kW and for  $h= 5.8$  cm and  $\varnothing_{int}= 18$  cm.

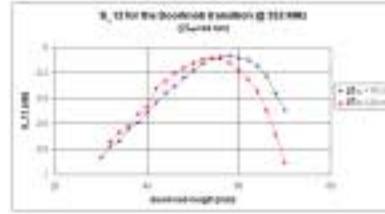

Fig. 9: Transmission from waveguide to coax as a function of doorknob height.

Following these results we would choose a doorknob transition with  $h= 5.8$  cm and  $\varnothing_{int}= 18$  cm. The drive loop that protrudes in the cavity has been extensively simulated with HFSS in order to find the critical coupling conditions. It has also been checked that the direct perturbation of the loop on the RFQ field is acceptable. The inner conductor of the coaxial line and part of the external conductor are water-cooled.

#### 5 ACKNOWLEDGEMENTS

We are grateful to D. Schrage (LANL) and M. Vretenar (CERN) for fruitful discussions on the main RFQ construction details. H. Frischholz, G. Geschonke and H. P. Kindermann (CERN) have given a fundamental help in conceiving the high power coupling.

#### REFERENCES

- [1] A. Pisent et al. “TRASCO 100 MeV high intensity Proton Linac” EPAC 2000, “<http://trasco.lnl.infn.it>”
- [2] L. M. Young et al. “High Power Operations of LEDA”, this conference.
- [3] M. Comunian et al. “TRASCO RFQ desing” EPAC 2000.
- [4] J.H. Billen and L.M. Young, “POISSON SUPERFISH”, LA-UR-96-1834.
- [5] G. Lamanna et al. “Tests of a Radio-Frequency Quadrupole Cold Model” PAC99, p. 3522-3525
- [6] G. Geschonke, private communications.
- [7] J.Jacob et al., “Commissioning and Operation of One Booster and Two Storage Ring RF Acceleration Units at the ESRF”, in EPAC '92 Conference Proceedings, Berlin, March 1992.