

PERFORMANCE OF THE PLS HIGH PRECISION MAGNET POWER SUPPLIES

J. H. Suh[†], K. M. Ha, S. H. Jeong, S. J. Park, Y. J. Han, J. Y. Huang, and S. H. Nam
 Pohang Accelerator Laboratory, POSTECH

Abstract

In the PLS (Pohang Light Source), more than 200 units of uni-polar and bi-polar high precision magnet power supplies (MPS's) have been operated since 1994. The uni-polar MPS's are 12-step SCR rectifier type, and the bi-polar MPS's are H-bridge type choppers that adopt IGBT's. Also, 144 units of transistor linear-type shunt controllers for the BBA (Beam-Based Alignment) application were added in 1997. The storage ring operation of the PLS starts with injection of 2-GeV beam from the PLS linac, and the beam energy is ramped to 2.5 GeV for normal operation by increasing operation currents of MPS and output powers of RF stations. In this paper, we discuss technical details and performance-test results of the PLS high precision MPS's, and introduce our upgrade plan of the MPS's

1 PLS MAGNET POWERSUPPLY STRUCTURE

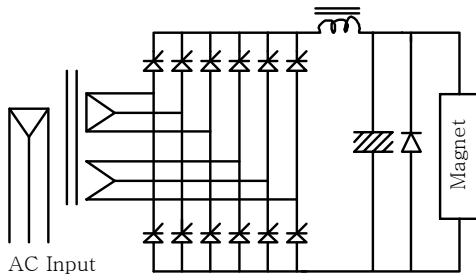

Figure 1: Uni-polar MPS structure.

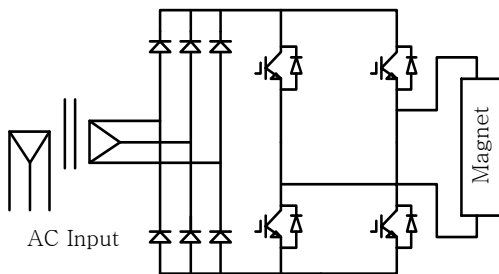

Figure 2: Bi-polar MPS Structure.

Fig. 1 and 2 show structures of uni-polar and bi-polar MPS's respectively. Uni-polar MPS's are 12-step SCR rectifiers and Bi-polar ones are H-bridge type choppers using IGBT's. Main advantages of these include simple operation, maintenance and upgrade.

2 TRANSISTOR LINEAR TYPE SHUNT CONTROLLER FOR BBA

Transistor-type linear shunt controllers are connected in parallel with quadrupole power supplies for the orbit correction of stored beam. Total 144 BBAPS (Beam Based Alignment Power Supply) are installed in 1997. BBAPS can control 10% of quadrupole magnet current. Fig. 3 and 4 show the wire connection of BBAPS and quadrupole MPS.

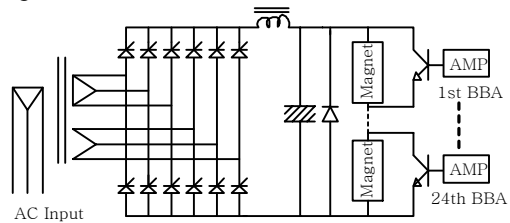

Figure 3: Quadrupole & BBA PS (Q1, 2, 3).

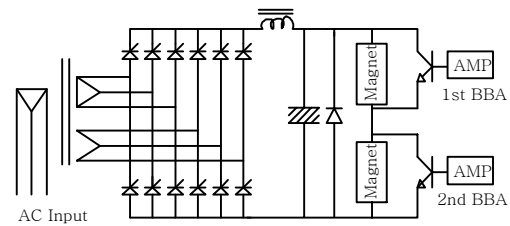

Figure 4: Quadrupole & BBA PS (Q4, 5, 6).

3 UNI-POLAR RAMPING CONTROLLER

In the PLS, beam energy is ramped to 2.5 GeV after beam fill-up at 2.0 GeV. In this process, MPS currents should be ramped accordingly and had been done by the VME system, before special ramping controllers were installed to each uni-polar MPS's in 2001. They feature dual interface ports of VME and Ethernet and can afford real time control of 42 uni-polar MPS's. Fig. 5 shows the functional diagram of uni-polar ramping controller. The master section keeps communicating with control console via TCP/IP. Slave sections are distributed along 42 uni-polar MPS's and series connected through fiber optics. During the ramping and de-ramping operations, MPS's are controlled by the master section of the ramping controller and returns the control to the VME upon completion.

[†]gto@postech.ac.kr

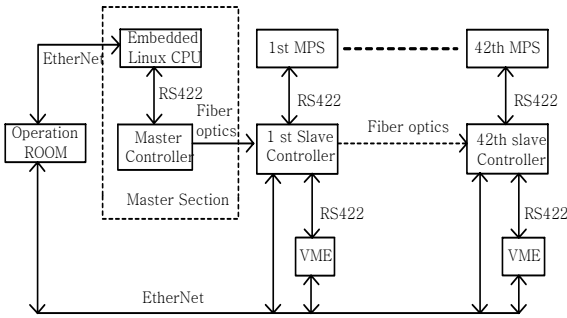

Figure 5: Uni-polar MPS Ramping Controller.

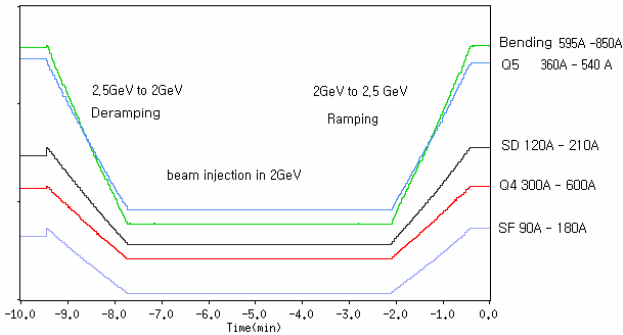

Figure 6: Uni-polar MPS Ramping, De-Ramping Current curve.

4 BIPOLAR DIGITAL INTERFACE

140 corrector MPS's, that are operating in the PLS storage ring, are bi-polar. Controllers for these MPS's communicate with the VME system in a parallel-bit manner. Dedicated controllers for the global orbit feedback has been developed and installed in Dec. 2001. They have dual communication ports, serial and Ethernet. Control speed as fast as 100 μ s and 500 ms over 140 corrector MPS's have been achieved via parallel communication and Ethernet respectively. Control software is based on EPICS (Experimental Physics & Industrial Control System) using MODBUS/TCP protocol. Fig. 7 shows the diagram of corrector MPS controller. Synchronized control of 140 MPS's can be achieved by the serial communication.

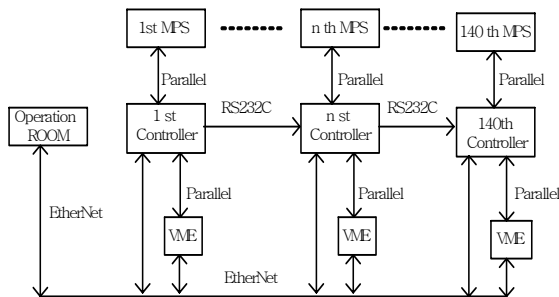

Figure 7: Corrector MPS Orbit Feedback Controller.

5 MEASUREMENT RESULT OF MPS PERFORMANCE

In the U7-undulator beamline, fluctuation of photon intensity has been observed with frequency peaks at ten to several tens of Hz. We have found strong correlation between the photon intensity fluctuation and current ripples of MPS's. This triggered an intensive effort to reduce MPS ripples and, as the first step, low-level feedback electronics and LC filter of the bending MPS have been improved. See Fig. 8 for the improvement scheme of the LC filter and 9 & 10 for BPM signals (short-term orbit stability) before and after the LC filter improvement.

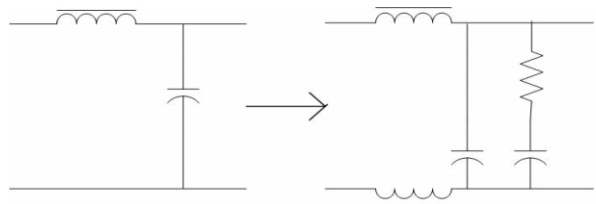

Figure 8: Bending MPS LC Filter structure change.

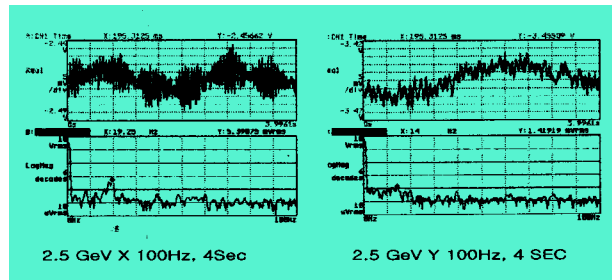

Figure 9: BPM signal before Bending MPS LC Filter change.

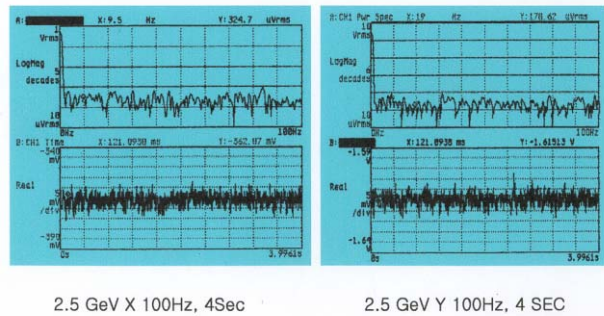

Figure 10: BPM signal after Bending MPS LC Filter change.

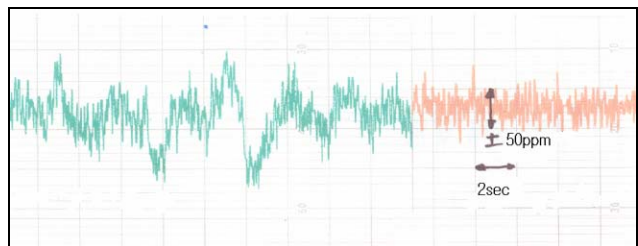

Figure 11: Current stability before and after Bending MPS improvement.

6 FUTURE UPGRADE PLAN OF MPS

Dramatic upgrade of whole MPS system would require big budget. In this context, we are going to maintain the present system structure. As the efforts for improving unipolar MPS's, we have changed LC filter structure, optimised the bandwidth of V-I regulator, and stabilized 6.6 kV AC line and MPS room temperature. We are also changing present 12-bit DAC's to 16-bit ones for improving control resolution. In addition, development of bi-polar MPS's with transistor linear type and 18-bit DAC are underway.

7 CONCLUSION

Stability of MPS's is directly related to the beam stability of storage ring. R&D's are under way for improving stability of MPS's toward ± 10 ppm.

8 REFERENCES

- [1] K. M. Ha, J. H. Suh, J. C. Yun, D. W. Kim, U. H. Lee, T. Y. Lee, J.Y. Hung, S. H. Nam "STORAGE RING ENERGY RAMPING CONTROL SYSTEM DEVELOPMENT REPORT," PAL-PUB 2001-006 May 2001
- [2] K. M. Ha, J. H. Suh, J.Y. Hung, S. H. Nam "Storage Ring Corrector MPS Control System for Global Orbit Feedback," PAL-PUB 2002-006 Feb 2002
- [3] S. H. Nam, J. H. Suh, K. M. Ha, J.Y. Hung, and I. S. Ko "HIGH CURRENT SHUNT REGULATOR FOR QUADRUPOLE MAGNETS IN PLS 2GeV STORAGE RING," 1997 PAC
- [4] S. H. Nam, S. H. Jeong, S. H. Han, J. H. Suh, K. M. Ha, and M. YOON "MAGNET POWER SUPPLIES OF PLS 2GEV STORAGE RING," 1996 European PAC
- [5] M. KUMADA, K. SATO, S. MATSUMOTO, K. NODA and E. TAKADA, "Synchrotron Power Supply of Sub-ppm Ripple Current," NIRS-M-112 HIMAC-012, Jan 1996
- [6] B. H. Kwon, Jae-Hak Suh and Sung-Hun Han "Novel transformer Active Filters," IEEE TRANSACTIONS ON INDUSTRIAL ELECTRONICS, 40, NO3, pp. 385-388, JUNE 1993
- [7] B. H. Kwon, E. H. Song "Design of Current Source Using 12-pulse Phase-Controlled Rectifier," IEE PROCEEDINGS-B, Vol. 138, No. 4, JULY 1991
- [8] WATER F. PRAEG "A High-Current Low-Pass Filter for Magnet Power Supplies," IEEE TRANSACTIONS ON INDUSTRIAL ELECTRONICS AND CONTROL INSTRUMENTATION, VOL. IECI-17, NO. 1, pp16-22, FEBRUARY 1970