

An FEL Power Source for a TeV Linear Collider

D. B. Hopkins, E. H. Hoyer, K. Halbach and A. M. Sessler
Accelerator & Fusion Research Division, 1 Cyclotron Road
Lawrence Berkeley Laboratory*, Berkeley, CA 94720

W. A. Barletta, R.A. Jong, L. L. Reginato and S. S. Yu
Lawrence Livermore National Laboratory#
University of California, Livermore, CA 94550

J. R. Bayless
Pulse Sciences Inc.
5330 Derry Avenue, Suite J
Agoura Hills, CA 91301

Stanford Linear Accelerator Center@
Stanford University, Stanford, Ca 94305

R. B. Palmer
Brookhaven National Laboratory@
Upton, NY 11973

I. Introduction

In this paper we consider the design of a power source for a linear collider. We take a conservative approach and hence extrapolate as little as possible from present experience. Thus we establish a "straw man"; i.e. a design which serves as an "existence proof" of a power source for a TeV collider.

We take as the parameters to which the power source is designed those presented earlier by R. Palmer¹; namely:

$$\begin{aligned} f &= 17 \text{ GHz}, & R &= 180 \text{ Hz}, \\ W &= 634 \text{ MW/m}, & L_c &= 7.41 \text{ km}, \\ L &= 1.44 \text{ m}, & T_p &= 50 \text{ ns}, \\ W_T &= 3.87 \text{ TW}, \end{aligned}$$

where the quantity f is the desired frequency, W is the power needed per meter (for a gradient of 186 MeV/m), L is the length between feeds, W_T is the total power required, R is the rep-rate, L_c is the total length of the collider, and T_p is the rf pulse width. With no emittance dilution, this collider would produce a luminosity of $7.7 \times 10^{32} \text{ cm}^{-2} \text{ sec}^{-1}$ for single bunch operation or $1.6 \times 10^{34} \text{ cm}^{-2} \text{ sec}^{-1}$ for multi-bunch operating (i.e. 21 bunches). With realistic dilution and $R = 386 \text{ Hz}$ these luminosity values would be 5.0×10^{32} and $1.0 \times 10^{34} \text{ cm}^{-2} \text{ sec}^{-1}$, respectively.

II. FEL Design

For the power sources we consider FELs. The experience at ELF needs only be extrapolated a small amount to cover this case.² Recall that we operated at 35 GHz and obtained a power of 1.8 GW; so that we need only reduce the frequency by a factor of two (and in the easy direction) and, as we shall see below our design is for 5 GW, so that we need only extrapolate the power up by less than a factor of three.

We have used the numerical simulator FRED to study the FEL. We find a case which has the following properties:

$$\begin{aligned} E &= 3.5 \text{ MeV}, & B_0 &= 4.11 \text{ kG}, \\ \gamma &= 7.85, & aW &= 3.26 \\ I &= 3 \text{ kA}, & P_i &= 80 \text{ kW} \\ a \times b &= 6 \text{ cm} \times 3 \text{ cm}, & P_0 &= 5.0 \text{ GW}, \\ \lambda W &= 12 \text{ cm} & \eta &= 47 \%, \\ L &= 1.7 \text{ m}, & \Delta E/E &= 0.8 \%, \end{aligned}$$

where E is the energy of the electron beam of peak current I . The wiggler has wavelength, λW , and length L . The waveguide is rectangular and has dimensions $a \times b$. The wiggler is tapered beyond 80 cm, and the peak, initial field on axis is B_0 . Some details of the FRED run are shown in Figs 1- 7. The final field is 1.8 kG, which provides focusing so that the final beam size is not too large.

* Work performed under the auspices of the U.S. Department of Energy by the Lawrence Berkeley Laboratory under contract No. DE-ACO3-76SF00098.

Work performed under the auspices of the U.S. Department of Energy by the Lawrence Livermore National Laboratory under contract No. W-7405-ENG-48.

@ Work performed under the auspices of the U.S. Department of Energy under contracts No. DE-ACO3-76SF00515 (SLAC) and DE-AC02-76C0016 (BNL).

The energy tolerance ($\Delta E/E$) shown above corresponds to a microwave phase variation of 20 degrees. This is a tight tolerance and we have made some effort to "understand it" and to reduce it. The tolerance of 20 degrees comes from a study of beam dynamics in the main linac.³ For systematic phase errors it is only ~2 degrees. For the case of a number of power sources (N) with truly random phase errors, the allowable phase variation per source is increased by a factor of \sqrt{N} .

III. Induction Linac Design

The next task is to design an induction accelerator that can produce the requisite beam. It is rather easy to meet each of the listed requirements from the FRED results except the energy stability requirement. We believe that it is possible to construct induction linacs with a pulse having about a 1% flat top, but the present generation of linacs operate at a higher value.

IV. Wiggler Design

Now we design a wiggler to meet the above requirements. Allowing for contingencies, we choose a wiggler length of 2.0 m, rather than 1.7m as shown above. Our design is a conventional hybrid permanent magnet wiggler, but rather inexpensive and simple. A drawing of a period of the wiggler is given in Figure 8.

V. Re-Acceleration

We note, from the FRED run, that the basic power source is 47% efficient. It is tempting to put some of them together (on the way to making a Two-Beam Accelerator (TBA)) so as to increase the overall efficiency. For example, even two re-accelerations will make a considerable difference as we show in Table 4 (a reduction from \$990 M to \$746 M; i.e., a saving of \$ 244 M and an increase in efficiency from 67% to 76%). The "afterburner" mentioned in the table, incidentally, is a final relativistic klystron output coupling stage (RK). This improves overall efficiency by extracting rf energy from the bunched beam before it is dumped. Note that our analysis is more complete than that given above in that we have now added microwave equipment costs.

In Table 4, the quoted beam-to-rf efficiency is based on peak power ratios; e.g. for the Basic Unit, $\eta = 7.0 \text{ GW}/(3.5 \text{ MV} \times 3 \text{ kA}) = 0.67$. The overall efficiency shown is based on energy values and implicitly includes the efficiency of the pulse-power chain plus a factor of 50/70 [ns] which accounts for the absence of beam during the rise-and fall-time of the driver pulse. For the Basic Unit, the overall efficiency is then (rf output energy)/(driver energy) = $7 \text{ GW} \times 50 \text{ ns}/(2 \times 691 \text{ J}) = 0.25$ (see Figure A.1). For the case with three reaccelerations, the overall efficiency is $(22 \text{ GW} \times 50 \text{ ns})/(5 \times 691 \text{ J}) = 0.32$.

Table 4 demonstrates the advantage of reacceleration and indicates the importance of studying the matter further. To this end we have made some FRED runs to study re-acceleration. We take the induction units as delta-functions; i.e., we give the particles an increase of energy, but no change in phase. The results of two re-accelerations, each of 2 MeV, and with 10% of the power taken across (so as to have a bucket at the start of each section), are shown in Figures 9-14.

VI. Costs

Costs are presented in Tables 1 and 2. The linac costs are rather complicated and are broken down by categories. On the other

hand, the wiggler is rather straightforward and very inexpensive by comparison. In Appendix A we discuss in detail the basis for these costs and the key assumptions used in preparing them. Also, system diagrams, calculations, and an explanation of terminology are presented.

In fact, the wiggler cost is seen to be negligible compared to the induction linac cost, which implies that our considerations hold also for relativistic klystrons. In fact, the choice between an FEL and a RK should be made on other grounds than cost. Such things as sensitivity to energy errors, emittance, beam current (i.e., linac performance), complexity of operation, and reliability are of greater importance than the difference in cost in selecting between these two approaches.

VII. Discussion

Firstly, we have designed, and costed, a conservative FEL power source for a TeV collider. Our design is very conservative in that induction linacs very similar to the one we desire have been built and operated. The wiggler employs technology which has been employed previously; the performance we desire is very close to that already achieved at ELF. Furthermore, we emphasize that the cost estimates are to be taken seriously, for they come from experience and are not, as someone remarked about something else "only one viewgraph deep". In order to satisfy the collider needs, we require 774 rf power sources of 5 GW each. The costs associated with the most conservative linac design is given in Table 1 in the first four columns ("Present Technology"). Each one costs \$1.79 M (Injector + Accelerator). To this must be added the cost of the wiggler, which is delineated in Table 2. The total cost of the power supply portion of the collider, going with these power supplies, is \$1.44 B as is tabulated in Table 3.

Secondly, we have designed and costed a "Small Cell Technology" FEL. This design incorporates features which, although we think they can be incorporated into a power source design, represent departures from present experience (although this technology is just now being developed at LLNL). A detailed cost breakdown is given in Table 1 in columns G through J ("Small Cell Technology"). Since each unit costs \$1.54 M, to which must be added the wiggler cost, the total cost of a unit would be \$1.61 M. The power supply for the collider costs \$1.25 B.

A third induction accelerator, using our best estimates of the result of industrialization, is costed in the last column of Table 1. The total cost for the collider is now reduced to only \$770 M.

Finally, we have considered, but not costed, a "multi-beam" induction linac coupled with a number of wigglers. No one has built such a linac, and the beam dynamics may well prevent building such a device (although a similar device has been seriously considered, studied extensively, and even built, for heavy ions). The cost of an induction linac increases with beam current. There may be no saving from using a higher current unit since this requires a larger and more complicated injector and a higher-energy driver.

An even more radical approach, but still worthy of serious attention, is to produce a "flat beam" and then send it through one wiggler. No one has studied space charge effects in an FEL with a flat beam, but it would seem that one could operate in this way with a rather intense beam without experiencing the deleterious effects of space charge. If so, the cost saving would result from only making one (but somewhat wider) wiggler. We note that the wiggler expense is negligible, so that the saving here is small and the increased risk is considerable.

In fact, our chosen 3kA design is very close to an optimum in cost vs. current. Our studies indicate the need to build some units and study energy stability. Most importantly, our studies show the importance of working with industrial partners and attempting to get closer to the "Industrialized Technology" case, for only this case has a respectable cost.

VIII. Conclusions

At \$1.44 B and \$1.25 B respectively, costs for the Present Technology option and the Small Cell Technology option can be considered upper bounds on the cost of power sources for a TeV linear collider. On practical grounds, this cost is probably too high by a considerable amount.

The Small Cell Technology with re-acceleration three times, at a total cost of \$706 M, shows much promise for tolerable costs

and efficiency. Reacceleration has been shown to reduce costs by ~29%. Similar savings should be realized in the other two options if reacceleration is incorporated into the design. This technique should therefore be vigorously investigated.

The projected industrialized version, even without re-acceleration, at a cost of \$770 B, has an attractive cost. This option should also be vigorously investigated.

Appendix A Induction Linac Costs

In this section we present the basis and key assumptions applied in the preparation of the induction linac cost estimates shown in Table 1.

Cost Estimate Basis

The cost estimates presented in Table 1 for the three power supply options are based on "first unit" costs; that is, the units are assumed to be the first test units constructed having all of the design features finalized in an R and D program. The engineering support costs shown, for example, are only those required for engineering oversight of the first-unit construction, not for the full engineering design of the units.

It would be of great interest to know what cost savings could be made by fabricating large numbers of the units employing the techniques of full industrialization and mass production. Such an estimate is not included here since we have little confidence in our ability to credibly make such an estimate at this time. However, savings of at least 30 to 40 % seem feasible.

The costs shown in the first two options of Table 1 are generally based on the cost optimization principles and scaling formulae given in Reference 4 with recent upgrades of some of the coefficients to reflect reality and a 1988 cost basis. Each of these options are discussed in detail below following an explanation of the terminology employed.

Terminology

In Tables 1 and 2 we employ the terminology:

"Transport" involves the solenoidal magnets required for beam focusing, steering and matching.

Is and ps" refers to the intermediate energy storage and power supply which precedes the driver.

LCW" is low-conductivity cooling water.

Elec. fluids" includes insulating oil and freon.

"I and C" means instrumentation and control.

"S and E" means miscellaneous materials, supplies and expenses.

REC material" refers to rare-earth cobalt permanent magnet material.

Present Technology Option

Figure A.1 shows the equipment configuration addressed in the cost estimate for the Present Technology linac. Note that whereas both the injector and the accelerator have RC networks to compensate for a time-increasing ferrite magnetization current, only the injector cells have shunt resistive loading. This reduces the sensitivity of beam energy to current fluctuations and also provides compensation so as to eliminate "pulse droop". In principle, a multiple-network compensation circuit could achieve the same result, but at the price of increased complexity and higher cost. A tapered-impedance blumlein (i.e., the pulse forming line or PFL) in the magnetic compressor driver (MC), now undergoing development, could compensate for the pulse droop in a more energy-efficient manner. This technique, although not yet qualifying for Present Technology status, is assumed for the Small Cell Technology option. Figure A.2 shows a simplified diagram of an MC pulse power chain.

Injector We have assumed that the 3kA beam current will be emitted from a 3.5 in diameter dispenser cathode, yielding a current density of 48 A/cm². Although this value of current density exceeds that typically achieved in certain accelerators (eg ETA II and ARC), it has been achieved by W.C.Turner, LLNL, in a clean, unbaked vacuum system with an extraction gradient of 90 kV/cm.⁵ We assume even better conditions will prevail in operating injectors.

(Of course, periodic replacement of cathodes will be required.)

Given a 3.5 in diameter cathode, we assume the beam pipe has a 3.5 in entrance aperture and a 2.0 in exit aperture. We allow a one inch radial space inside the ferrite for a solenoidal magnet winding. The radial electric field between the beam pipe and the magnet I.D. has a maximum value of about 243kV/cm at the beam pipe surface. This is regarded as a reasonable working stress for properly prepared stainless steel surfaces.

We have assumed a 33% value for the cell resistive loading. Given this choice and the beam pipe diameter of 3.5 in, the remaining parameters are derived as follows:

Beam load/cell=250 kV, 3.0 kA, 70 ns
 Ferrite puck dimensions=9 in I.D., 20 in O.D., 1 in thick
 Assumed current for ferrite magnetization and RC compensation=1.0kA
 Resistive load current=(0.33)(3+1)=1.33 kA
 Cell current=3+1+1.33=5.33 kA
 Energy/cell=(250 kV)(5.33 kA)(70 ns)=93 J
 MC output energy=(93 J/cell)(6cells)=558 J
 Assumed efficiency for MC and CRC/IES=90%
 CRC/IES output energy=558/0.9=620 J
 Power supply output energy=(620)(0.9)=689 J.
 Required AC power input=(689 J)(180 pps)/0.9=138 kW

During commissioning of injectors following cathode replacement, precise control of beam energy is important. Because of this need and the extreme dependence of beam quality on cathode position and MC driver excitation, present technology would opt for separately controllable drivers for the injector and accelerator. These are costed in Table 1. A supporting argument for two drivers is that there is less concern over fault-mode MC damage than with a higher energy single driver. In addition, the injector requires more extensive supports and cathode positioning mechanisms, etc, than does the accelerator. The relatively higher costs for these features is reflected in the "Strongback" costs of Table 1. The cost of the filament, cathode and anode assemblies, plus the reentrant stalks, is included in the Injector Sub-Assembly category.

The Transport category includes the cost of the solenoidal and crossed dipole steering magnets in each cell, the beam transport solenoid between the injector and the accelerator, and all required power supplies and instrumentation. Cell block costs are based on recent commercial fabrication costs for ETA II cells and the scaling of these as the square of the outer diameter. The cost of the ceramic insulator and its assembly is also included, as is the cost of the headers, RC compensators and loading resistors.

Based on recent quotes, the estimated cost of the required ATA-sized ferrite pucks is \$1660, each, for more than 1000 pieces. The injector ferrite cost is thus \$(1660)(7/cell)(6 cells)=\$70k.

The cost of the MC, intermediate energy store and driver power supply is based on recent ETA II experience. Costs have been scaled linearly with stored energy. Thyatron switching technology is assumed since, for meeting the modest 180 pps requirement, it is the method with many years of demonstrated success.

The remaining categories in Table 1 should be self-explanatory except for Instrumentation and Control. This category includes allowances for four beam monitors, eight data channels, capacitive probes for the cathode assembly and induction cells, and all associated instrumentation. Also included are the costs for the vacuum, fluid control, rf monitoring and X-radiation monitoring sub-systems, as well as for the filament power supply and controls. No allowance has been included for a particular fraction of the overall collider control system.

Accelerator Having a larger number of cells than the injector, the accelerator requires a greater number of most of the components discussed above. The Transport costs reflect this accordingly. Given the same beam loading as for the Injector, the Accelerator parameters are:

Ferrite puck dimensions= 6 in I.D., 16 in O.D., 1 in thick
 Assumed current for magnetization and RC compensation=1 kA
 Cell current=(3+1)=4 kA
 Energy/cell=(250 kV)(4 kA)(70 ns)=70 J
 MC output energy=(70 J/cell)(8 cells)=560 J

Note that the last parameter is essentially identical to that for the Injector. Therefore the two MC drivers can be identical, effecting further cost savings and simplicity.

The strongback required is a simple stand; the robust accelerator assembly is its own strongback. Requirements for I and C are somewhat less than for the injector. The cost of a beam dump is included.

Small Cell Technology Option

Injector For this option, we have assumed that the injector will be identical to that discussed for the Present Technology option.

Accelerator A more compact, smaller diameter cell design is assumed for this option. This makes cost reductions possible in several categories, as evidenced in Table 1. With smaller ferrites, their magnetization current is reduced, increasing overall efficiency, as is the required RC compensation. For efficient elimination of a drooping pulse top, a shaped Blumlein would be incorporated into the MC design. A 2.2 in diameter beam pipe is assumed. Other parameters are:

Beam load/cell=200 kV, 3 kA
 Ferrite puck dimensions= 4 in I.D., 8 in O.D., 1 in thick
 Number of ferrites/cell=12
 Assumed current for magnetization and RC compensation=333 A
 Cell current=(3+ 33)=3.33 kA
 Energy/cell=(200 kV)(3.33 kA)(70 ns)=47 J
 MC output energy=(47 J/cell)(10 cells)=470 J
 Assumed efficiency for MC and CRC/IES =90%
 CRC/IES output energy=470 J/0.9=522 J
 Power supply output energy=522/0.9=580 J
 Required AC power input=(580 J)(180 pps)/0.9=94 kW

Note that the beam coupling efficiency has increased to 3.0 kA/3.33 kA=90% as compared to 75% for the Present Technology option.

The major cost improvements are in the cell block and ferrite categories. Recently, similar size cell blocks were commercially fabricated for \$2 k each. The cost shown in Table 1 includes the cost of headers and RC compensation networks. The ferrite costs are based on the price recently paid for such ferrites by another LLNL research group.

Projected Industrialized Technology Option

The third power source option assumes that the benefits of projected industrialized technology apply. The estimates are based on actual induction accelerator fabrication experience in the private sector (at Pulse Sciences, Inc., Agoura Hills, CA). A 15% allowance has been made for profit and warranty.

The reader must use caution in making comparisons between this option and the other two since the industrialized accelerator configuration is somewhat different. The assignment of certain costs into the categories of Table 1 requires some words of explanation, which are provided below.

The configuration addressed is a 1.26 MeV injector module plus two eight-gap accelerator modules, each producing a 1.12 MeV acceleration. The precision parts, such as the accelerator gaps, insulators, and solenoids, are arranged in a removeable beam line assembly. Rather than having individual accelerating cells for each gap, overall steel modular boxes serve as housings for the ferrite and containers for insulating oil. The beamline can be removed without disturbing the ferrites.

The ferrite dimensions are 9 in I.D., 20 in O.D., and 1 in thick. Accelerating gap voltage is 140 kV. There are four ferrites/gap and 25 total gaps required. The injector unit has a 3.5 in diameter cathode with re-entrant cathode and anode stalks. In addition to driving the 3 kA beam, the MC must provide an additional 1 kA for the ferrite magnetization current and RC compensation. No resistive loading is provided at the injector. A single MC driver, having 1050 J stored energy, drives the entire injector/accelerator system. The corresponding required power input is 233 kW.

As explained earlier, the costs shown in Table 1 are for a first unit, not mass-produced. The Transport category includes the cost of the solenoidal coils, the injector anode stalk, and the precision beam line assembly. Although there are no cell blocks, per

se, the cost of the modular steel housings are assigned to this category.

Ferrite costs are based on recent quotes. It appears likely that increased competition from new suppliers may soon make possible ferrite cost reductions of 25-30%. The cost of the MC driver has been estimated separately, but is found to agree well with a cost which scales linearly with stored energy.

For the I and C category, the cost for a minimum of diagnostics has been included since it is assumed that the design will have been well de-bugged and experimentally characterized in an earlier R and D program.

References

1. R. Palmer, "The Interdependence of Parameters for TeV Linear Colliders", SLAC-PUB-4295, April 1987; also private communication.
2. T. Orzechowski et al, Phys. Rev. Lett. 58, 2172 (1986).
3. R. D. Ruth, "Multi-Bunch Energy Compensation" SLAC-PUB-4541, 1988; also private communication.
4. W.A. Barletta, "Cost Optimization of Induction Linac Drivers for Linear Colliders", UCRL-95909, Presented at the Workshop on New Developments in Part. Accel. Techniques, Orsay, France, July, 1987
5. W. C. Turner, "High Brightness, High Current Density Cathode for Induction Linac FEL's"; To be published in the Proc. of 1988 Linear Accelerator Conf., October 3-7, 1988; also private communication.

Table 1. Costs of an Induction Driver

| | Present technology | | Small cell technology | | Industrialized |
|-------------------------|------------------------|-----------------------------|------------------------|-----------------------------|----------------|
| | Injector (0 - 1.5 MeV) | Accelerator (1.5 - 3.5 MeV) | Injector (0 - 1.5 MeV) | Accelerator (1.5 - 3.5 MeV) | |
| Transport | 80 | 120 | 80 | 115 | 50 |
| Accelerator cells | 460 | 400 | 460 | 235 | 580 |
| cell blocks | 130 | 110 | 130 | 50 | 40 |
| ferrites | 70 | 70 | 70 | 30 | 140 |
| MAG Compressor | 130 | 130 | 130 | 80 | 240 |
| i.s. & p.s. strongback | 70 | 80 | 70 | 70 | 140 |
| | 60 | 10 | 60 | 5 | 20 |
| Ancillary systems | 120 | 160 | 120 | 140 | 165 |
| Vacuum | 30 | 30 | 30 | 10 | 40 |
| Fixture & Align | 5 | 5 | 5 | 5 | 20 |
| LCW | 1 | 1 | 1 | 4 | 5 |
| Elec. fluids | 4 | 4 | 4 | 1 | 10 |
| I & C | 80 | 70 | 80 | 70 | 70 |
| Dump | | 50 | | 50 | 20 |
| Injector sub-assemblies | 60 | | 60 | | 70 |
| Total components | 720 | 680 | 720 | 490 | 865 |
| Assemble | 70 | 70 | 70 | 50 | 20 |
| Engin. support | 50 | 50 | 50 | 30 | 30 |
| S&E | 80 | 70 | 80 | 50 | 10 |
| SUB TOTAL | 920 | 870 | 920 | 620 | 925 |
| TOTAL | | 1790 | | 1540 | 925 |

Table 2. Cost of FEL Wiggler

| | |
|---------------------|------|
| REC material | 12 |
| magnet structure | 11.1 |
| support system | 1 |
| vacuum chamber | 0.9 |
| ancillary systems | 2.5 |
| Component sub-total | 50 |
| Engineering support | 7.5 |
| installation | 1.2 |
| contingency | 12.5 |
| TOTAL | 71.2 |

Table 3 FEL POWER SOURCE SUMMARY

(No costs for microwave components and no after burner.)

| Technology | Induction Linac | Wiggler | Total |
|---------------------------|-----------------|---------|---------|
| Present Technology | 1.79 MS | 71 kS | 1.44 BS |
| Small Cell Technology | 1.54 MS | 71 kS | 1.25 BS |
| Industrialized Technology | 93 MS | 71 kS | 77 BS |

Table 4 Re-Acceleration Various Number of Times

(Assume Small Cell Costs, an RK after burner, and a 3.87 TW total power requirement)

| Basic Unit | | Two Re-Accelerations | |
|------------------------------|-----------|------------------------------|-----------|
| Injector (0-1.5 MeV) | \$ 900 k | Base Unit Cost | \$ 1700 k |
| Accelerator (1.5-3.5 MeV) | \$ 420 k | Accelerators (x4 MeV) | \$ 1240 k |
| WJCMD and M* | \$ 250 k | WJM** | \$ 240 k |
| Base Unit Cost | \$ 1700 k | Unit Cost | \$ 4270 k |
| Power Output per Unit (15x2) | 7.0 GW | Power Output per Unit (15x2) | 17 GW |
| Total Cost (553 units) | \$ 900 M | Total Cost (228 units) | \$ 746 M |
| Beam to rf Efficiency | 67% | Beam to rf Efficiency | 76% |
| Overall Efficiency | 25% | Overall Efficiency | 31% |

| Single Re-Acceleration | | Three Re-Accelerations | |
|-------------------------------|-----------|------------------------------|-----------|
| Base Unit Cost | \$1700 k | Base Unit Cost | \$ 1700 k |
| Accelerator (x2 MeV) | \$ 620 k | Accelerators (x6 MeV) | \$ 1800 k |
| WJM** | \$ 120 k | WJM** | \$ 300 k |
| Unit Cost | \$ 2500 k | Unit Cost | \$ 4010 k |
| Power Output per Unit (10 x2) | 12 GW | Power Output per Unit (20x2) | 22 GW |
| Total Cost (323 units) | \$ 817 M | Total Cost (176 units) | \$ 706 M |
| Beam to rf Efficiency | 73% | Beam to rf Efficiency | 77% |
| Overall Efficiency | 29% | Overall Efficiency | 32% |

* Wiggler, Relativistic Klystron, Microwave Driver, and Microwave Equipment
 ** Wiggler and Microwave Equipment

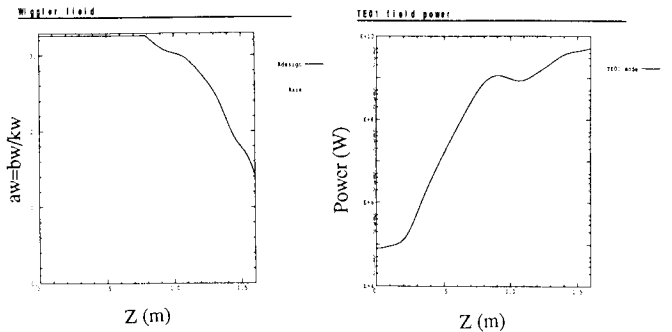

Figure 1. The peak wiggler field on axis in the tapered design. The taper was developed by trial and error so as to maximize the FEL performance.

Figure 2. The power in the fundamental mode as a function of distance down the wiggler.

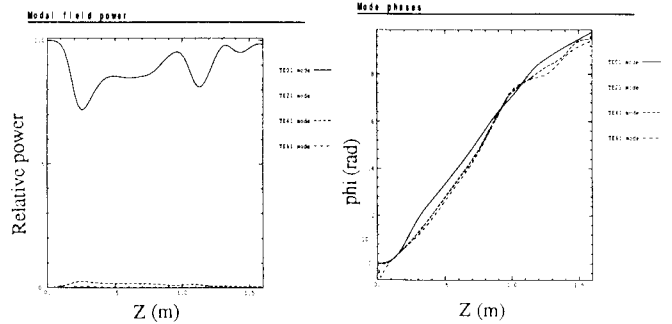

Figure 3. Relative modal power in the FEL. It is important to have most of the power in the fundamental.

Figure 4. Phase of the rf, in the various modes, as a function of distance down the wiggler.

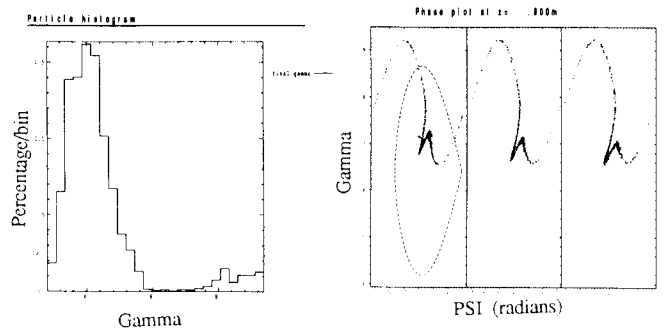

Figure 5. A particle histogram which shows the efficiency of capture, and loss, of particles.

Figure 6. A phase plot at the initiation of taper. The effect of space charge is very apparent.

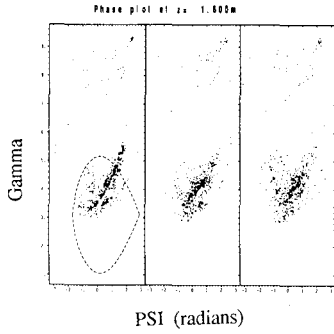

Figure 7. Phase plot at the end of the wiggler. The bunching of particles is quite effective.

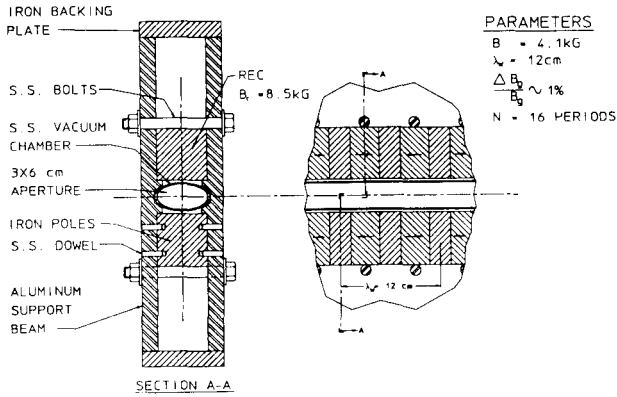

Figure 8. A diagram of a section of the wiggler showing the iron and permanent magnet material.

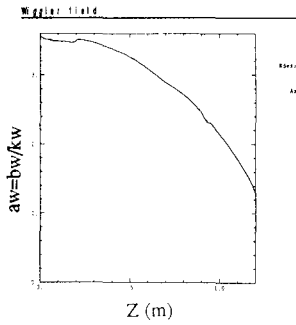

Figure 9. Peak wiggler field on axis in the first re-acceleration section.

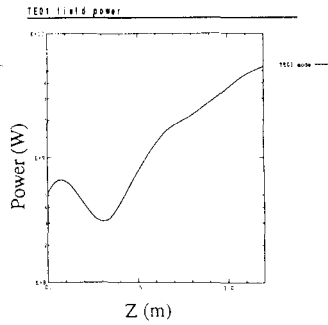

Figure 10. Power in the fundamental mode as a function of distance down the first re-acceleration section.

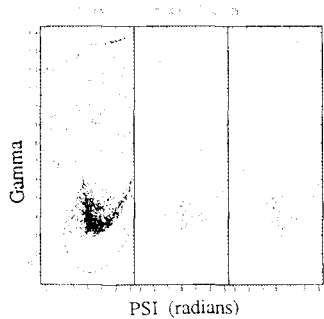

Figure 11. Phase plot at the end of the first re-acceleration section.

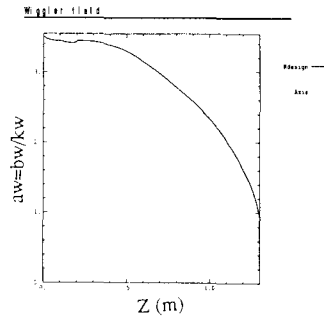

Figure 12. Peak wiggler field on axis in the second re-acceleration section.

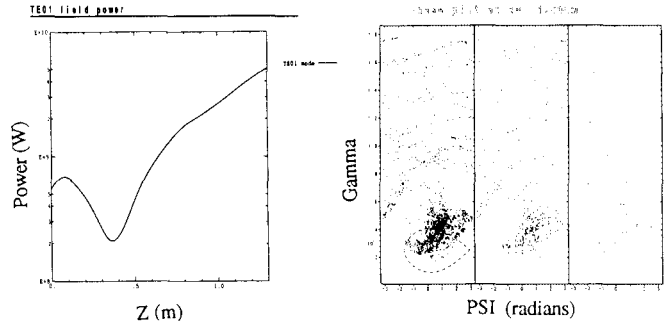

Figure 13. Power in the fundamental mode as a function of distance down the second re-acceleration section.

Figure 14. Phase plot at the end of the second re-acceleration section. This figure allows one to judge the likelihood of further extraction by an FEL (compare it to Figure 11) or by a relativistic klystron.

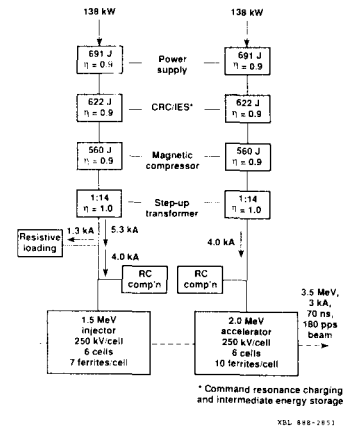

Figure A.1 Present technology linac configuration.

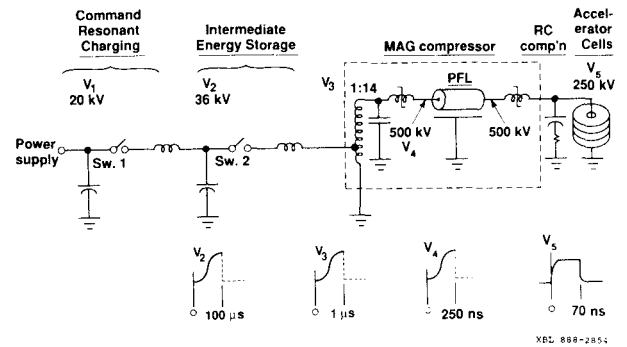

Figure A.2 Simplified schematic diagram of a pulsed power chain.