

BUNCH PHASE DISTRIBUTION DETECTOR FOR THE ISTR A ION LINAC BEAM

A.M.Tron, I.G.Merinov, N.Ya.Popova¹, K.V.Voznesensky¹
 MPhI, Kashirskoe sh. 31, 115409 Moscow, Russia
¹ ITEP, 117259 Moscow, Russia

Abstract

Secondary electron rf-detector is the only beam diagnostic instrument at present for longitudinal profile measurement of short ion bunches. The detector with longitudinal rf-modulation of secondary electrons in capacity gap of quarter-wave coaxial resonator with a helical inner conductor is considered for the measurement (with phase resolution of about one degree of 148.5 MHz) of the ISTR A ion linac beam with pulsed current up to 200 mA at ion energy of 3...36 MeV. The detector description and bench testing results of its main units will be presented.

Introduction

The proton linac ISTR A-36 [1] creating at ITEP for the first model of radwaste transmutation plant requires appropriate beam diagnostic provision to understand and minimize beam-loss. Detector for ion bunch phase distribution measurements with resolution of about 1° for the power beam of the ISTR A linac is discussed in this paper. This beam diagnostic instrument is required, first of all, for precise beam matching and setting up rf-parameters of the accelerator cavities. The detector is the key tool in the longitudinal beam emittance measurement system that will be also accomplished using the existing bending magnets in the linac channel. Chosen method of the emittance measurement will allow to research the beam distribution in longitudinal phase space without any model assumption of it. First the method was proposed and successfully realised at the I-100 linac (IHEP) in 1980 [2]. Figure 1 makes clear it. The detector (9) was spaced after spectrometer (7) and at the 10 m distance from the I-100 linac.

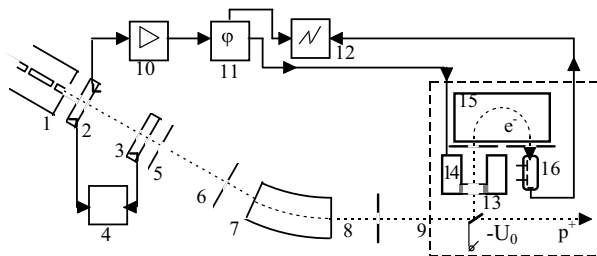

Fig.1. Emittance measurement system

Narrow momentum width of the collimator (8) of 0.1 % and small beam divergence (0.5 mrad) after collimators (5,6) allowed, in fact, to reserve the bunch phase distribution for separated part of the beam and, carrying out the same measurements at different particle momentum, to determine the distribution in the longitudinal phase space shown in Fig.2 where isolines of the beam distribution in the longitudinal

phase space at different density levels (pointed in left column of the table) and corresponding beam per cents and beam longitudinal emittance measured are presented too. More in detailed of it one can find in [3,4].

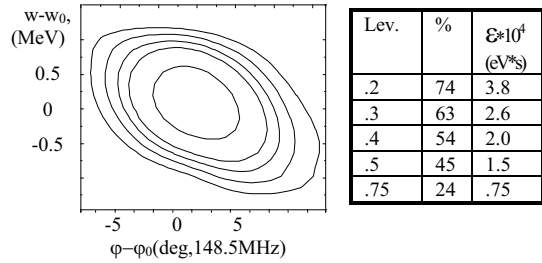

Fig.2. Emittance of the I-100 linac beam.

The principle of operation of the bunch phase distribution (BPD) detector (9) (Fig.1.) has been reported elsewhere [4,5]. Briefly, in the device the BPD of a high energy ion beam is isochronously transferred into the same distribution of the low energy secondary electrons which, then, is coherently transformed into transverse one through rf-modulation in the resonator gap (14) and spectrometer (15) allowing direct presentation it on a low frequency display (12).

Taking into account the beam space charge effect the detector realizing the same principle of operation has been chosen for the ISTR A beam.

BPD detector

The detector for the ISTR A linac beam proposed in [5] is schematically shown in Fig.3.

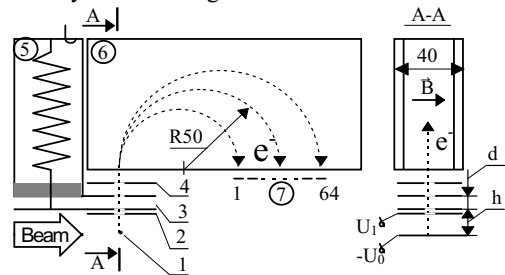

Fig.3. Layout of BPD detector.

There are some distinctions between the new detector and the mentioned above. Taking into account that the lower proton energy the higher its energy loss in the target, within considered beam energy range, the thin carbon fibre of 8 μm diameter was chosen to decrease the fibre heating under the beam. Moreover, for that diameter and high negative voltage (of about 8 kV) applied to the target (1) the phase dilution of

the secondaries on the distance (10 mm) until the collimator (2), caused by their initial energy spread, will be less than 0.01 deg. of 148.5 MHz (see Fig.3 in [6]).

To decrease the detector sizes a open quarter-wave coaxial resonator with a helical inner conductor was chosen the photo of which (before brazing) is shown in Fig.4.

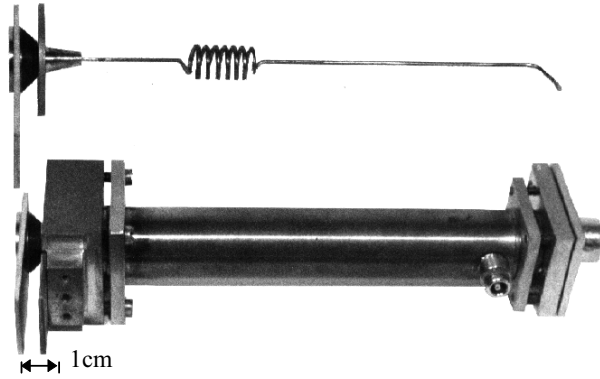

Fig.4. Photo of the open quarter-wave coaxial resonator of the detector (on 148.5 MHz).

At pulsed rf-power consumption of about 40 W the modulating gap voltage reaches demanded value of 2 kV. To suppress multipactoring the inductance part of the resonator contains an atmospheric air. Resonator feedthroughs are not vacuum - tight.

Multichannel collector (7) of the secondary electrons installed at the exit of the magnet spectrometer (6) allows to record a bunch phase distribution for a time less than the beam pulse duration, i.e. it will allow us to investigate changes of the phase distribution along the beam pulse. Estimations of separated pulsed charges of the secondaries at the entrance of the collector show that magnification of about 10^4 reached with installation of microchannel plates will be enough to record the phase distribution of the ISTRA beam in 100 points of its pulse. Below, everywhere, results of consideration will be presented for the following ion beam parameters: proton energy - 3 MeV, pulsed beam current - 150 mA, rms beam radius - 2.5 mm, beam pulse duration - 150 μ s, pulse frequency - 25 Hz.

It should be noted that the detector can be installed so that the ion beam axis will be perpendicular to the plane Fig.3, then the monitor size along the ion beam will be 40 mm [4].

Detector resolution

The detector phase resolution ($\Delta\phi$) is mainly defined by the phase dilution ($\Delta\phi_1$) of the secondaries on the distance $h = 10$ mm, the shutter phase resolution ($\Delta\phi_2$) and the additional phase dilution ($\Delta\phi_q$) caused by the ion beam space charge effect. As it was mentioned above $\Delta\phi_1 = 0.01^\circ$. In Fig.5 the phase dilution $\Delta\phi_q$ is plotted as a function of the target place

relatively to beam axis. Distance between the beam axis and the collimator of 10 mm is fixed.

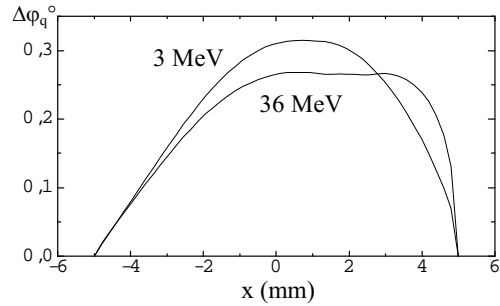

Fig.5. Electron dilution $\Delta\phi_q$ in deg. of 148.5 MHz caused by the beam space charge effect.

Then, considering the above mentioned quantities as the independences one can define $\Delta\phi$ using known algorithm from [5]. Figure 6 shows the dependence of $\Delta\phi$ vs. the electron input phase for the slit width of 1 mm of the collimator (4) and the main radius of electron trajectories in the magnet spectrometer of 50 mm.

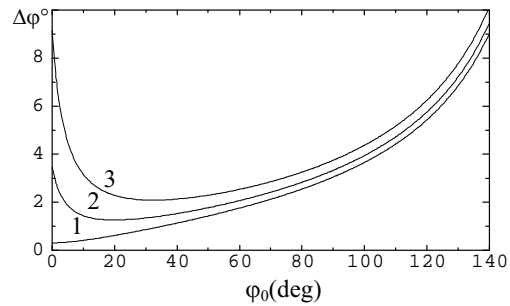

Fig.6. Detector resolution $\Delta\phi$ vs. ϕ_0 in deg. of 148.5 MHz at $U = 2$ kV and for different electron energies at the gap entrance: 1 - 2 keV; 2 - 2.2 keV; 3 - 2.5 keV.

One of the advantages of this technique is possibility to calibrate the detector using thermoelectrons from the target heated by a current. The $\Delta\phi_2$ resolution is determined by ratio of the relative initial momentum spread of the electrons at the gap entrance to the maximum increment of it due to the gap action which are measured by the magnet spectrometer when the gap is fed and not. Relationship U and the electron energy at the gap entrance is checked on the curve of the thermoelectron distribution in phase.

Target heating

There is important effect which limits the detector operation. When the temperature is beyond 2000 K the thermocurrent density can exceed the magnitudes compared with the secondary electron one. It ought to note too that for the tension of the wire it is necessary to know a possible

highest wire - target temperature because the limit of a elasticity strongly depends on the target temperature.

Taking into account that with decreasing proton energy its energy loss per unit length increases rapidly and velocity of the heat transport in the target is negligible small in comparison with a speed of heating under the beam the carbon fibre of 8 μm diameter was chosen. For this target and the above mentioned beam parameters (3 MeV) but for the pulse duration of 50 μs the maximum temperature dependence on a time is plotted in Fig.7.

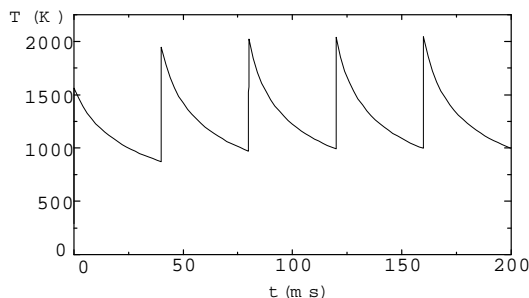

Fig.7. Carbon fibre temperature vs. the time for pulsed beam current of 150 mA at 3 MeV proton energy.

With increasing the pulse duration till 100 μs the increment of the maximum temperature for the pulse can reach 2500 K already. Hence, the main problem consists in the heating for a pulse, and the known flying wire technique [7] is not solution for it.

There are several ways, proposed in [8], to solve this problem. Shortly, these proposals, shown schematically in Fig.8, consist in the following. First, to avoid increasing the wire heating from pulse to pulse the wire is replaced on a length equaled to a beam diameter for a time between two beam pulses by means of winding up the wire (Fig.8.a) from bobbin (1) on (2) through the area occupied by the beam (5).

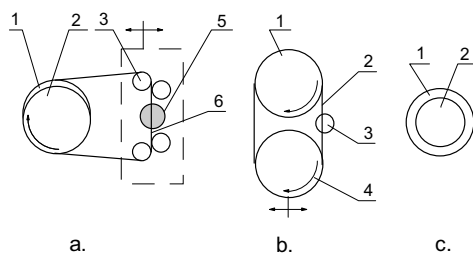

Fig.8. Targets with "running" and "boiling" wires.

To decrease the wire heating, at first, the speed of "running" wire is brought up to demanded one and after that it is moved in the beam. Fig.8.b explains the same principle of operation for a wire closed on itself when the wire speed can be very high. Lastly, Fig.8.c makes clear the proposal of "boiling" wire. A boiling heat for any material is known to be the most magnitude at a heating process. Then, applying thin coating of copper (1) on a tungsten core of a wire one can keep the core at the temperature being not more than the boiling-

point for a copper equaled to 2300°C. If we take this type of the wire for the RFQ2 linac beam at CERN [9] (with proton energy 750 keV) the copper layer of 5 μm will be enough to reserve the tungsten core of 100 μm diameter because a proton range for a copper is not more it.

Besides the mentioned, to extend the temperature range we could use the delta - electrons [10]. In the case it is not necessary to apply voltage to the target.

Conclusions

One can conclude that there is no limit of principle for using the secondary electron detector for bunch phase distribution measurements of a ion pulsed beam with average beam current up to 10 mA now. Proposed new target technique needs its experimental researches under intense ion beam.

Acknowledgments

Authors thank A.M.Kozodaev for support in part of this work.

References

- [1] A.M.Kozodaev, I.V.Chuvilo, A.A.Kolomiets et. al., "Proton 36 MeV, 0.5 mA Linac ISTR-36 as a Driven Multipurpose Irradiation Test Facility", Abstracts of EPAC 96, Barcelona, p.157 (1996)
- [2] A.M.Tron, V.N.Glushenko, V.A.Konov et.al., "Longitudinal Emittance Measurement of Proton Linac Beam", Abstracts of Conf. on Linacs, Kharkov, p.24 (1980)
- [3] A.M.Tron, "Secondary Electron Methods for Ion Phase Motion Research", Proc. 1990 Int. Linac Conf., Albuquerque, p.477 (1990)
- [4] A.M.Tron, "Secondary Electron Monitors in Linacs for Intense Neutron Sources", Proc. 1994 Int. Linac Conf., Tsukuba, p.917 (1994)
- [5] A.M.Tron, "Secondary Electron Monitors for Ion Bunch Phase Distribution Measurements", Proc. of the 2nd European Workshop on Beam Diagnostics, Truvmunde, p.60 (1995)
- [6] A.M.Tron, I.G.Merinov, "Secondary Electron Monitor for Electron Bunch Phase Distribution Measurement with Subpicosecond Resolution", Proc. of this Conf.
- [7] J.D.Gilpatrick, "On-line Diagnoses of High Current-Density Beams", Proc. EPAC 94, London, p.273 (1994)
- [8] A.M.Tron, "Detectors for Bunch Phase Distribution Measurements of Ion Linac Beam", will be published in Proc. of Accel. Conf., Protvino, Oct.1996.
- [9] M.Weiss, "The RFQ2 Complex: the Future Injector to CERN Linac 2", Proc. of EPAC 92, Berlin, p.539 (1992)
- [10] A.M.Tron, V.V.Smirnov, "Method of Bunch Phase Distribution Measurement Based on a Moller Scattering", Proc. of this Conf.