

TUNING OF THE CERN 750 MHz RFQ FOR MEDICAL APPLICATIONS

B. Koubek*, A. Grudiev, Y. Cuvet, C. Rossi, M. Timmins, CERN, Geneva, Switzerland

Abstract

CERN has built a compact 750 MHz RFQ as an injector for a hadron therapy linac. This RFQ was designed to accelerate protons to an energy of 5 MeV within only 2 m length. It is divided into four segments and equipped with 32 tuners in total. The RFQ length corresponds to 5λ which is considered to be close to the limit for field adjustment using tuners. Moreover the high frequency results in a sensitive structure and requires careful tuning by means of the alignment of the pumping ports and fixed tuners. This paper gives an overview of the tuning procedure and bead pull measurements of the RFQ.

INTRODUCTION

The HF-RFQ (High Frequency - RFQ) will be used as an injector for the LIGHT project [1], a linac based proton therapy facility. It accelerates protons from 50 keV to 5 MeV within 2 m and is designed to minimize beam losses above 1 MeV [2]. From an RF point of view the very compact 4-vane structure operates at about twice the frequency of existing RFQs [3]. It consists of four modules with a length of about half a meter. The dipolar modes are detuned by means of dipole stabilizer rods at the end plates. The electrode voltage is designed to be constant along the RFQ that requires a constant longitudinal field distribution in terms of tuning. In order to compensate construction errors the structure is equipped with 32 tuners. The 12 pumping ports could be used as additional tuning devices if necessary. The 4 power couplers are placed in the two middle segments of the RFQ, one in each quadrant. Each power coupler will be fed by a 100 kW Inductive Output Tube (IOT) in order to maintain a nominal voltage of 68kV. The Q-factor due to losses in copper is about 6500 according to 3D RF design simulations. The operation frequency is set to 749.48 MHz.

BEAD PULL SYSTEM AND TUNERS

For bead pull measurements on a 4-vane RFQ a bead has to travel through all 4 quadrants consecutively. The bead pull setup is shown in Fig. 1. It is based on the system which was previously used for the measurements of the LINAC4 RFQ at CERN [4] and has been adapted to the dimensions of the HF-RFQ. A wire with 0.3 mm diameter was used and the tension was adjusted with a spring. The wire is set in one closed loop that enables consecutive measurements of all four quadrants while the bead can be pulled around the pulleys to travel between the quadrants. For each quadrant the wire can be adjusted in azimuthal direction using micrometer screws.

The RFQ's length is 5λ which is considered to be a limit for using only tuners to adjust the field [3]. For these tuners a cone-shaped design was chosen in order to minimize RF

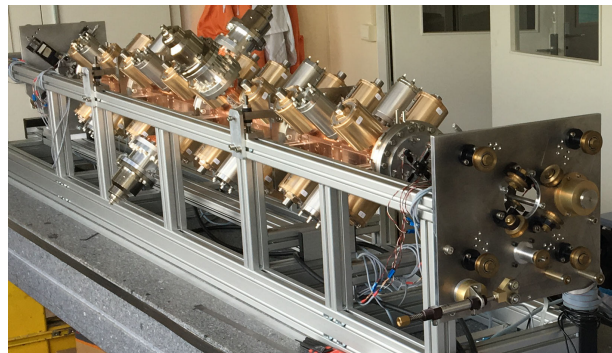

Figure 1: Support with the bead pull system and mounted RFQ.

losses and to be large enough to provide adequate tuning range and sensitivity. All tuners were manufactured with an additional length of 11 mm and a special tool was used in order to adjust the tuner's penetration depth with a 10 μm accuracy. After the tuning process the tuners were cut to their individual length and inserted with the same radial and angular orientation using this tool. Figure 2 shows a cross section of this tool with an inserted tuner.

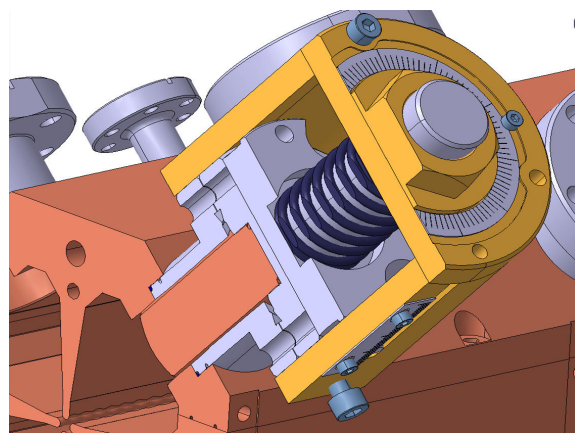

Figure 2: Tuner tooling for precise adjustment for tuning and final assembly after cutting.

RF MEASUREMENTS

The objective of tuning is to provide the proper field distribution according to the beam dynamics requirements and also to adjust the operation frequency. All RF measurements have been done at the defined operating temperature of the RFQ at 24 °C. For precise frequency adjustment the cavity was filled with dry nitrogen to avoid any influence of air humidity. Figure 3 shows a measurement of the mode spectra of the RFQ.

For the field measurements the standard bead pull method was used. The bead was made of aluminum and has a cylindrical shape with rounded edges. It has a length of 7 mm

* benjamin.koubek@cern.ch

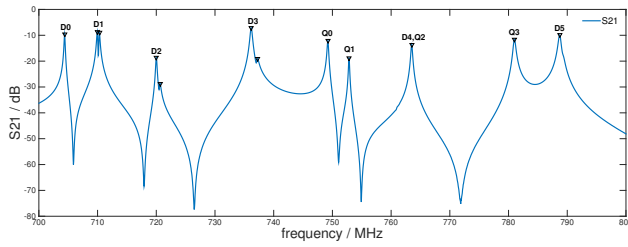

Figure 3: Mode spectra of the fully assembled of the RFQ.

and a diameter of 4 mm. By inserting the bead into the cavity the frequency changed by 0.014 MHz and the phase by 12.3° which was well in the linear range. The fields in each quadrant of the RFQ were measured separately followed by several steps of data processing to align the measurements to each other. Then the corresponding quadrupolar and dipolar components of the fields were defined by

$$Q = (B_1 - B_2 + B_3 - B_4)/4 \quad (1)$$

$$Ds = (B_1 - B_3)/2 \quad (2)$$

$$Dt = (B_2 - B_4)/2 \quad (3)$$

Where B_i are the measured fields of the quadrants, Q is the quadrupolar component, Ds and Dt the two dipolar components. The Q-component is meant to be at the nominal field level and constant over the length of the structure. For tuning it is sufficient to know the relative deviation of the field component along the structure. Therefore Q is defined to be 100% on average. Ds and Dt would ideally be zero. As an example Fig. 4 shows the initial bead pull measurement of the Q, Ds and Dt components after all tuners have been installed at the nominal positions.

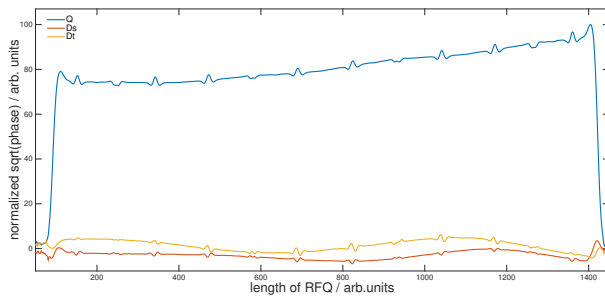

Figure 4: Initial measurement of the Q, Ds and Dt component of the fully assembled RFQ.

The Q component shows an error of $\pm 10.8\%$, Ds $\pm 3.0\%$ and Dt $\pm 3.6\%$. The small bumps in Fig. 4 are related to the tuners and the pumping ports.

TUNING

The RFQ is equipped with a set of 4 tuners, one in each quadrant, at 8 longitudinal positions. By adjusting the penetration depth of the tuners the magnetic field distribution in longitudinal direction can be adjusted in each quadrant independently. The goal of tuning is to find a mechanical

setting for each tuner that provides a constant longitudinal field distribution for the quadrupole mode (Q). The dipolar components (Ds, Dt), should be zero or minimized to a small fraction of the quadrupole component.

After moving one tuner the field distribution is measured. Then the derivative of every field component at a certain longitudinal location with respect to the tuner movement can be determined. By doing this for all tuners one by one a response matrix \mathbf{M} can be obtained that describes the influence of every single tuner on the field components at every longitudinal location.

$$\mathbf{M}_{i,j} = \sum_{j=1}^{32} \frac{\partial \vec{V}_i}{\partial \vec{T}_j} \quad (4)$$

where i is the number of measurement locations along the RFQ and j is the number of tuners. Then the relation between the desired change in field distribution and the change of the tuner settings can be described by

$$\vec{V} = \mathbf{M} \cdot \vec{T} \quad (5)$$

The vector \vec{V} represents the change of quadrupole and dipolar field components at different locations along the RFQ, the \vec{T} vector describes the difference between the actual and desired tuner settings [5]. By inverting matrix \mathbf{M} one can obtain a solution for the new tuner settings \vec{T}' which would correspond to the desired field distribution \vec{V}'

$$\vec{T}' = \mathbf{M}^{-1} \cdot \vec{V} \quad (6)$$

Since this set of equations is over-determined the matrix \mathbf{M} is non-square and ill conditioned. But still a solution can be found by using the singular value decomposition (SVD) method. By manipulating the singular values an optimum solution for field compensation can be found. Due to errors in the tuner adjustment and the fact that the tuner movement does not influence field and frequency in a perfectly linear way the procedure has to be repeated several times. Hence obtaining the desired field distribution is an iterative process.

The initial longitudinal field distribution and the RFQ frequency was measured after assembly of the four modules, pumping ports, tuners, power couplers and the end plates that include the dipole stabilizer rods. Then the measurement of the field distribution was repeated for every single tuner movement in order to obtain the response matrix \mathbf{M} , Eq. (4). To describe the longitudinal field 11 measurement locations were chosen. This in addition with 32 tuners leads to a non-square matrix \mathbf{M} . As a result of inverting matrix \mathbf{M} using SVD, 32 solutions for tuner settings (\vec{T}_{svd_i}) were obtained. By using the original matrix \mathbf{M} and the solutions for the tuner setting \vec{T}_{svd_i} predictions for \vec{V} called \vec{V}_{svd_i} could be calculated using Eq. (5). By comparing \vec{V} with the different \vec{V}_{svd_i} an optimum solution for the tuner setting could be found. Figure 5 shows the field that has to be compensated (dark blue line) and the predictions for the field compensation for the first iteration (purple line).

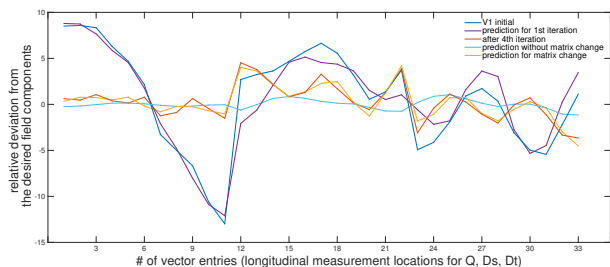

Figure 5: Predictions of field compensation.

For comparison the initial longitudinal field distribution of the different components is shown in Fig. 6 also in blue. The vector entries shown on the horizontal axis of Fig. 5 represent the 11 longitudinal measurement points for Q (1-11), Ds (12-23) and Dt (24-33). Not all results were suitable solutions. For example some predictions could result with a good agreement in \vec{V} but a too large tuner displacements clearly out of the mechanical tuning range and vice versa. The purple line shows very good agreement for the quadrupole component, that is also quite good for compensation of the dipole components. From this chosen solution the matrix and its corresponding tuner settings were used to do four iterations. After the fourth iteration (red line) no significant change of the quadrupole or dipolar field distribution was expected anymore (light blue line in Fig. 5). Then a matrix of another solution with better capability to compensate especially the dipolar components was chosen (yellow line in Fig. 5). Two more iterations with this second matrix lead to a good compensation of the dipolar components. Results compare to the yellow line in Fig. 6.

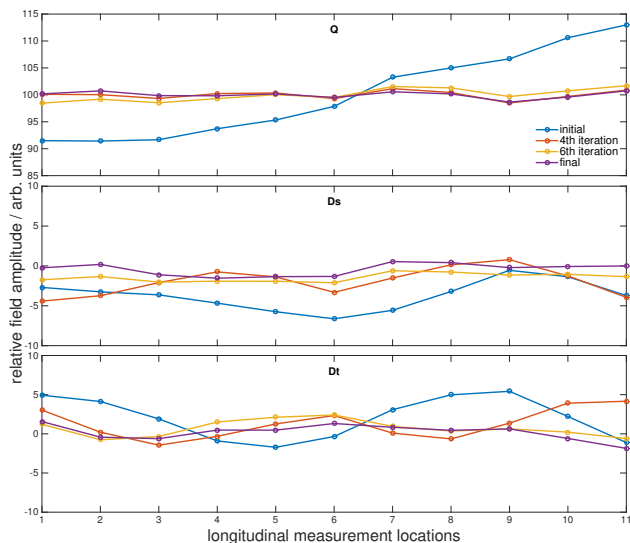

Figure 6: Different steps of compensating the longitudinal field distribution of Q, Ds and Dt components.

After six iterations the field distribution of all components was in an acceptable range. Figure 6 shows the initial, the one before and after matrix change and final longitudinal field distribution. The field errors after tuning are $\pm 1.0\%$

for the Q component and $\pm 1.0\%$ for Ds, $\pm 1.7\%$ for Dt, respectively.

Since the tuning algorithm is not able to adjust field and frequency at the same time the frequency had to be adjusted separately after the field tuning process. Therefore all tuners had to be moved equally to approach the target frequency of 749.48 MHz, a subharmonic of the LIGHT S-band cavities operating at 2997.92 GHz. For the frequency adjustment the temperature in the RF lab was set to the working temperature of the RFQ and the measurements have been executed with dry nitrogen for which the scaling factor can be precisely calculated. Also the wire had to be compensated to find the proper target frequency in order to check the field distribution after frequency adjustment with bead pull measurements, Fig. 7 shows the frequency at the different tuning and frequency adjustment steps. After the proper frequency was set the field distribution was confirmed to have no significant changes.

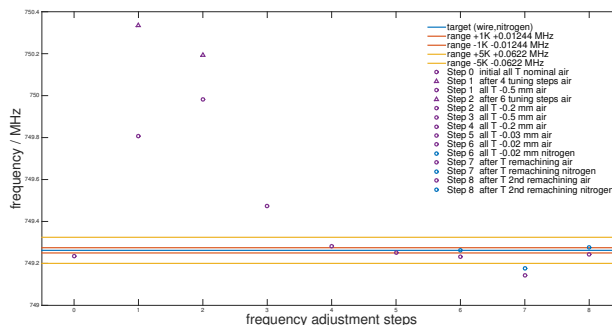

Figure 7: Frequency adjustment steps.

MEASUREMENT OF Q-FACTORS

To be on a safe side for the RF losses in operation the design values for quality factors are $Q_0 = 6440$ and $Q_{ext} = 21900$ leading to an 18% over-coupled case. Measurements for the 4 power couplers yield in an average $Q_0^{meas} = 6570$ and $Q_{ext}^1 = 26060$, $Q_{ext}^2 = 27878$, $Q_{ext}^3 = 27878$, $Q_{ext}^4 = 21410$. From these measurements an effective $Q_{ext}^{eff} = 6376$ was calculated. This results in a slight over-coupling of 3%.

SUMMARY

The tuning of the 750 MHz RFQ has been successfully completed. After 6 steps of iterations a tuner setting was found to provide a field distribution that is more than acceptable according to beam dynamics. After tuning, the frequency was adjusted by moving all tuners equally until the desired operation frequency was reached. Then the tuners were cut to the final length and assembled with the final copper gasket to the cavity. After the final tuner assembly all measurements have been confirmed followed by measurements of the Q-values and by field probe calibration that enables one to monitor the field distribution during operation of the RFQ. The RFQ is now ready for vacuum and power testing.

REFERENCES

- [1] LIGHT, <http://www.avopl.com/Our-LIGHT-system/Product-overview>
- [2] M. Vretenar, A. Dalocchio, V.A. Dimov, M. Garlasché, A. Grudiev, A.M. Lombardi, S. Mathot, E. Montesinos, and M. Timmins, “A Compact High-Frequency RFQ for Medical Applications”, in *Proc. LINAC'14*, Geneva, Switzerland, paper THPP040 (2014) <http://jacow.org>
- [3] A.M. Lombardi, V.A. Dimov, M. Garlasché, A. Grudiev, S. Mathot, E. Montesinos, S. Myers, M. Timmins, and M. Vretenar, “Beam Dynamics in a High Frequency RFQ”, IPAC'15, Richmond, USA, paper WEYB2 (2015) <http://jacow.org>
- [4] C. Rossi, P. Bourquin, J.B. Lallement, A.M. Lombardi, S. Mathot, D. Pognat, M. Timmins, G. Vandoni, M. Vretenar, M. Desmons, A. France, Y. Le Noa, G. Novo, and O. Piquet, “Progress in the Fabrication of the RFQ Accelerator for the CERN LINAC4”, in *Proc. LINAC'10*, Tsukuba, Japan, paper TUP042 (2010), <http://jacow.org>
- [5] Thomas P. Wangler, “RF Linear Accelerators”, WILEY-VCH Verlag GmbH & Co. KGaA, Weinheim (2008).