

# AN ITERATIVE LEARNING FEEDFORWARD CONTROLLER FOR THE TRIUMF E-LINAC\*

M. Lavery, K. Fong, TRIUMF, Vancouver, BC, Canada

## Abstract

In the TRIUMF e-linac design, beam stability to within 0.1% within 10 usec in pulse mode is a design requirement. Traditional feedback control systems cannot respond within this time frame, so some form of feedforward control is needed. Even conventional feedforward may not be sufficient due to differences between the required feedforward signal and the actual beam-loading current. For this reason, an adaptive feedforward system using an iterative learning controller was developed for the e-linac LLRF. It can anticipate repetitive beam disturbance patterns by learning from previous iterations. The design and implementation of such a control algorithm is outlined, some simulation results are presented, and some preliminary test results with an actual cavity are illustrated.

## INTRODUCTION

Some background information on the TRIUMF electron linac is first outlined. The design of the feedforward system is then described. Some simulation results are presented. Finally some test results using the system with an actual cavity are detailed.

## THE TRIUMF E-LINAC

A diagram of the current e-Linac accelerator showing the installation stages is shown in Fig. 1.

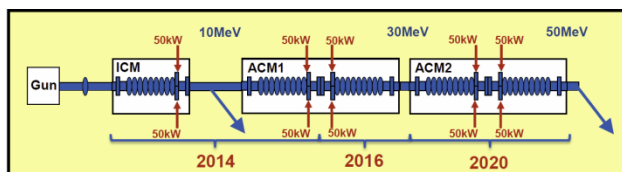

Figure 1: TRIUMF e-Linac schematic[1].

The system includes an electron gun biased at 300 kV, capable of 10 mA CW, and modulated at 650 MHz. A dielectric waveguide is used to carry the rf to the gun. An injector cryomodule containing a single 9-cell 1.3 GHz cavity follows. Next come two accelerating cryomodules each containing two 1.3 GHz 9-cell cavities. The accelerating cryomodules are each driven by a single klystron with power splitting and phase adjusters for the four couplers. Each cavity operates at 10 MeV for a total of 50 MeV of acceleration or 0.5 MW of beam power.

\* TRIUMF receives federal funding via a contribution agreement through the National Research Council of Canada

## THE ITERATIVE LEARNING CONTROLLER

Figure 2 shows a block diagram of a typical iterative learning controller[2]. The rf components have been omitted for simplicity. The lower part of the diagram represents a conventional feedback controller. The upper part of the diagram includes the ILC controller and its associated memories for the error signal and output drive.

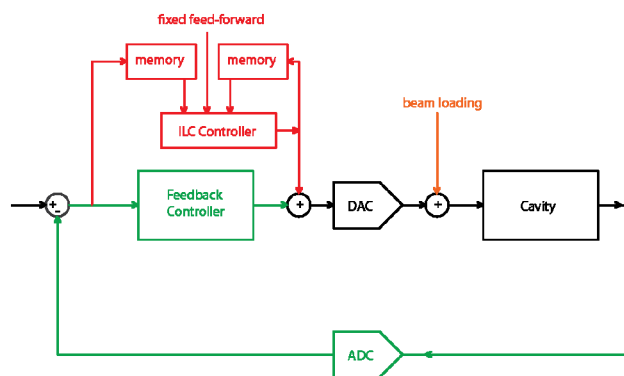

Figure 2: Iterative Learning Controller.

The ILC operates on the premise that the beam loading effect is repetitive from pulse to pulse. This makes it possible to “learn” the corrections needed to be applied to the drive for the next beam pulse. The learning function combines the drive and error signals from the previous iteration and constructs the correction signal to be applied to the present iteration. The ILC cannot correct for pulse to pulse variations in the system, cavity microphonics, or rf amplifier drive fluctuation. This means the conventional feedback controller is still required in the control system.

Initially, both causal (time delay  $\leq 0$ ) and non-causal (time delay  $> 0$ ) learning functions were examined. The former yielded results that appeared to converge initially, but then rapidly diverged and became unstable. This had been predicted theoretically from stability plots, and was confirmed in a time domain simulation (Fig. 3).

Figure 4 shows the comparable simulation results for a simple non-causal learning function. The learning function converges fairly rapidly without displaying the instability evident in the previous example. The learning function used for this simulation is a simple three sample moving average given by this discrete time equation:

$$u_{k+1}(T) = u_k(T) + \frac{1}{3}[e_k(T+1) + e_k(T+2) + e_k(T+3)]$$

It states that the next correction value is a function of the current correction as well as a moving average of the following three error samples.

**Simple Iterative Learning Controller Normalized Voltage Error**

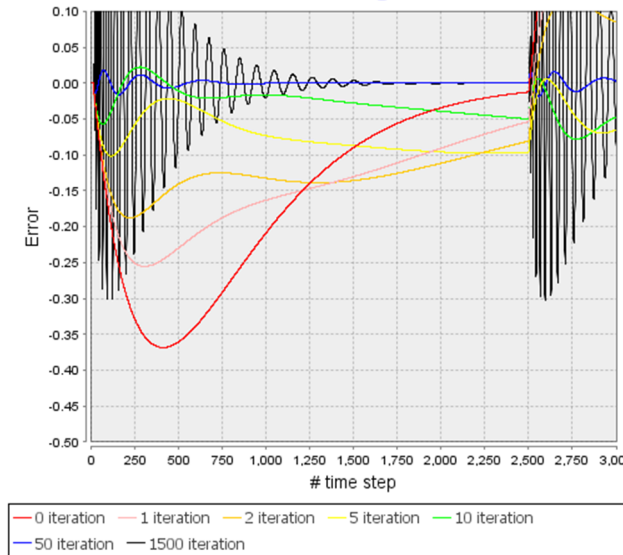

Figure 3: Causal ILC error.

**Look Ahead (non-causal) Iterative Learning Controller Normalized Voltage Error**

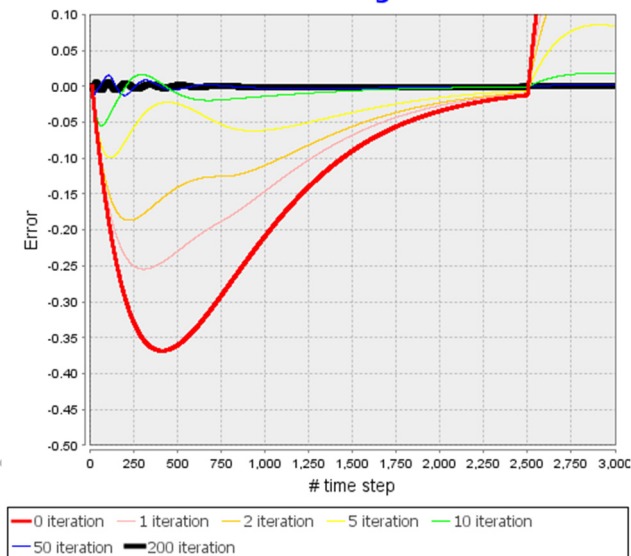

Figure 4: Non-Causal ILC error.

**ILC IMPLEMENTATION**

Examination of the proposed ILC algorithm and its computational and memory requirements seemed to indicate that it should be possible to implement with the existing DSP-based rf control system. Actually putting this into practice proved to be a bit of a challenge, however. One reason is that the existing PID control firmware already utilized most of the DSPs hardware resources. A second reason is that the available debugging tools proved to be very limited, forcing firmware changes to be made in very small increments.

Since the PID calculations use the current and two previous error samples, the moving average of three error samples can be derived at the same time, removing the need for an additional memory buffer for the error values. A single circular buffer is used to store and retrieve the ILC correction values. At a sampling rate of about 400k/sec and a pulse rate of 1 KHz, the depth of buffer required is about 400 samples, which is well within the memory available on chip.

Another practical issue that became evident during development is that it is possible to provide fairly good estimates of the amplitude and phase drive required to compensate for a given beam load. These values can then be used as a starting point for the ILC which then has the reduced task of compensating for slow drift of these parameters. To better allow testing and optimization of the ILC the fixed error gain used in the initial equation was made a user variable parameter. As well as allowing optimization, this also permitted slowing the ILC response to the point where it was easy to observe and record on an oscilloscope. The resulting ILC equation is shown below:

$$u_{k+1}(T) = u_k(T) + \frac{1}{n} [e_k(T+1) + e_k(T+2) + e_k(T+3)]$$

To simplify the calculation, the value of n used is limited to an integer power of two.

**ILC CAVITY TEST RESULTS**

For a couple of reasons, the ILC algorithm was not yet able to be tested on the target e-linac cavity. The main reason was a lack of beam time, as the system is still in the process of being fully tested and commissioned. The second reason is that the beam power levels tested so far are far below the design goals for the system, so that the beam loading effects would be minimal. To get around these problems and provide a test bed for the algorithm, an available normal conducting quarter-wave 140 MHz cavity was used. For the initial testing, a step transition of the fixed feedforward coefficient was used to simulate beam loading. In subsequent tests, a balanced diode modulator was used to modulate the cavity drive signal to simulate beam loading.

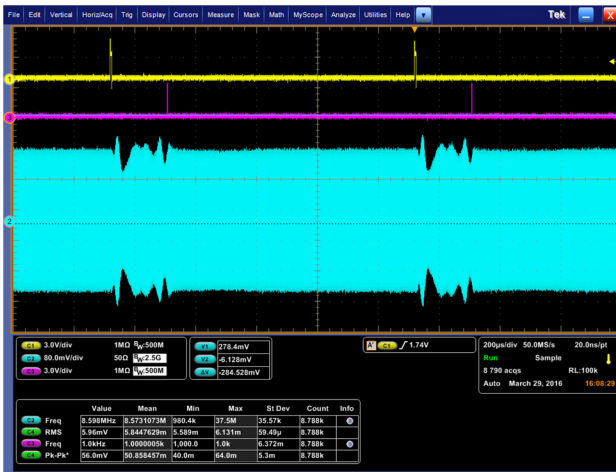

Figure 5: Causal ILC system response.

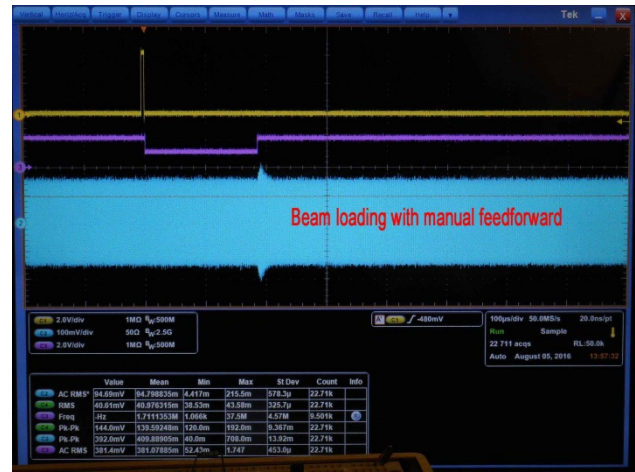

Figure 7: Beam Loading with fixed feedforward.

Figure 5 shows a snapshot of the response when a causal ILC system is utilized. The resulting oscillations are not stable and tend to increase with time until amplifier saturation limits are reached, confirming the theoretical and simulation results.



Figure 6: Beam loading w/o feedforward.

Figure 6 shows the cavity voltage with simulated beam loading before any feedforward correction signal is applied. Figure 7 shows the same picture with fixed feedforward correction applied. As might be expected with a stable loading value, the beam-loading effect is largely cancelled out. Figure 8 shows the effect of adding both the fixed feedforward correction and the ILC-generated values.

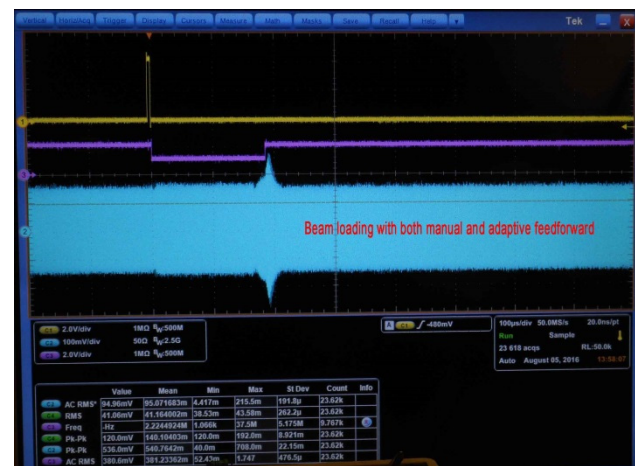

Figure 8: Beam loading w/Fixed + ILC FF.

## CONCLUSIONS

A causal ILC system for controlling beam loading was attempted and demonstrated to be unstable. This is due to the fact that the ILC involves an integration which, together with the PID algorithm, results in a double integration. Subsequently, a relatively simple non-causal ILC algorithm was tested and proved to be stable as well as offering relatively rapid convergence. Some work remains to be done to control the transient at the end of the beam pulse. While it largely does not affect the beam, if sufficiently large it can cause other problems such as amplifier trips. It also remains to test the system on a superconducting cavity.

## REFERENCES

- [1] R. Laxdal, *et al*, "ARIEL: Superconducting RF Linac for Isotope Production", Superconducting Science and Technology – Special Issue - Focus on Superconducting RF for Accelerators, October 2016 (to be published).
- [2] K. Fong, "Iterative Learning Controller for LLRF", TRIUMF Design Note TRI-DN-13-23.