

# HIGH CURRENT BEAM INJECTOR FOR CANCER THERAPY\*

L. Lu<sup>#</sup>, L. yang<sup>1</sup>, W. Ma<sup>1</sup>, T. He<sup>1</sup>, L.P. Sun, X.B. Xu, L.B. Shi, C.X. Li, Y. He, H.W. Zhao,  
Institute of Modern Physics (IMP), CAS, Lanzhou, China  
<sup>1</sup>also at University of Chinese Academy of Sciences, Beijing, China

## Abstract

A hybrid single cavity (HSC) type linac was developed as high current beam injector for cancer therapy. A prototype HSC machine had accelerated 5.2 mA C<sup>6+</sup> ions up to 25.7 MeV (2.1MeV/u) with a laser ion source (LIS). The ion injection method adopted a direct plasma injection scheme (DPIS). In beam testing, we found the measured beam parameters agreed with simulations. More details of the measurements and the results of the high power test are reported in this paper.

## INTRODUCTION

In the last decades, accelerator-driven cancer therapy has considered as a remarkably effective treatment [1]. However, the injection accelerators at existing facilities are large in size and expensive to run [2]. Our team proposed HSC type injector with DPIS as a way to reduce the cost of the cancer therapy facilities, and it was also proposed to use as injector for neutron source[3]. The HSC linac is an interdigital-H (IH) cavity combined a 4-rod type radio frequency quadrupole (RFQ) and a drift tube (DT) structure. The HSC cavity has both merits of RFQ and DT such as a better emittance in transverse, a higher transmission for low energy region in RFQ

structure and a better shunt-impedance in DT [4-5], and the power source for HSC acceleration is only one.

The design goal of the prototype HSC linac was to accelerate C<sup>6+</sup> ions up to 2.1 MeV/u from 25 keV/u in the 1800 mm, the designed resonator frequency was 100 MHz. In the beam conditioning, the linac operated in a pulsed mode, the duty was limited to 5% because of the maximum limit of the power source. The input current was designed as 20 mA and the transmission of whole cavity was calculated as 30%. The measured Q and frequency are 91% and 100.49 MHz, respectively. And the calculated shunt impedance based on perturbation measurements is 111.2 MΩ/m, which is 91% of the MWS simulated value of 122.2 MΩ/m. The shunt impedance value of 111.2 M/m for the HSC structure cavity is quite high compared to other linac structures within the same beam velocity region, as shown in Figure 2 [1][6].

Comparing to existing injection systems of cancer therapy facilities, the HSC injector can make the charge stripper (mainly change C<sup>4+</sup> or C<sup>5+</sup> ions to C<sup>6+</sup> ions) and the multi-turn injection useless, moreover, the uselessness of the multi-turn injection make the synchrotron magnets downsize.

The high power acceleration system of the prototype HSC is shown in Figure 1.

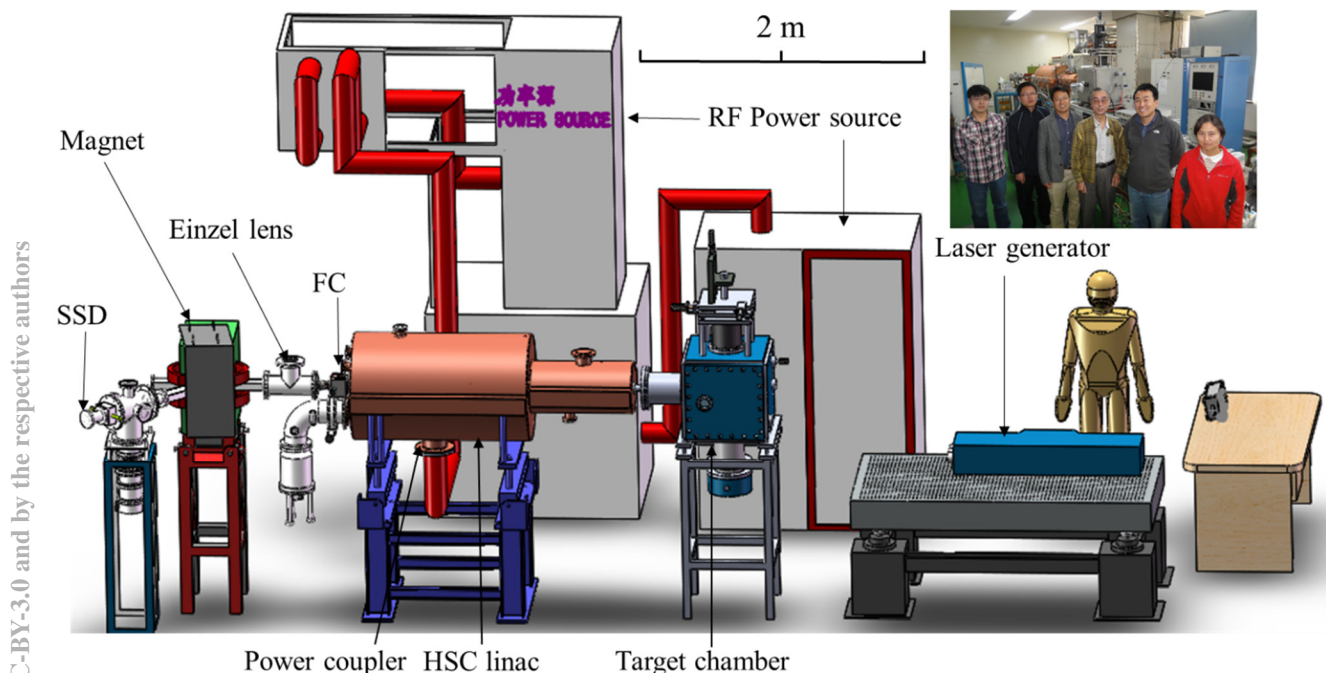

Figure 1: High power acceleration system for prototype HSC linac.

\* Work supported by NSFS and Youth Innovation Promotion Association of CAS

<sup>#</sup> luliang@impcas.ac.cn

### ACCELERATION RESULTS

A 250 kW RF power source and a maximum 3 joule (J) laser were used to provide powers for acceleration and high intensity  $C^{6+}$  ions. In the test of the LIS, 1.9 J laser energy was delivered to the focal point on the target. According to the calculations based on the LIS design shown in Figure 2, our LIS can deliver a maximum 17.5 mA  $C^{6+}$  ions to the RFQ parts of the HSC. Solid state detectors (SSD) installed on the beam line behind a 45-degree-bending-magnet were used to measure the beam signals, and two meshed, installed on the exit of the HSC and the position of the Faraday cup 1 (FC1), were set to cut off the ions for protecting the SSD. The calibration of energy channels for the SSDs was done by using  $^{241}Am$  source which mainly emits alpha particles with an energy of 5.486 MeV [7].

The simulated dissipation power of the HSC was 98 kW, and the measured Q was 91% of the simulated value. Thus, the necessary power for acceleration  $C^{6+}$  ion beam should be 108 kW, and an average 110 kW RF power was used to high power acceleration in the test.

The RF system and the measurement system are shown in Figure 3. The measured total accelerated beam current from the FC are shown in Figure 4. Two measured signals from the SSDs are shown in Figure 5.

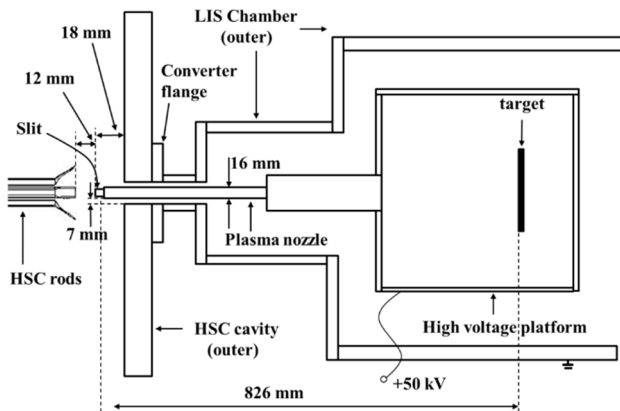

Figure 2: An image of the LIS and the injection system for HSC linac.

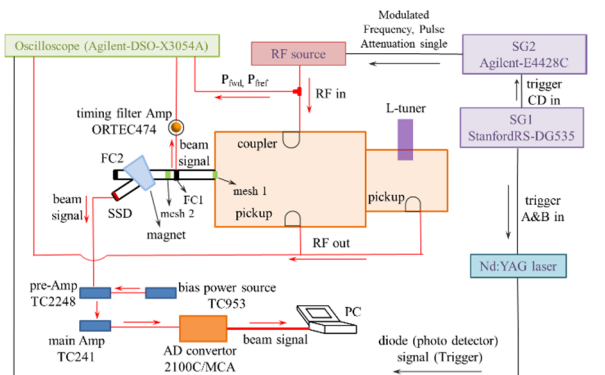

Figure 3: Layout of the RF system and the measurement system.

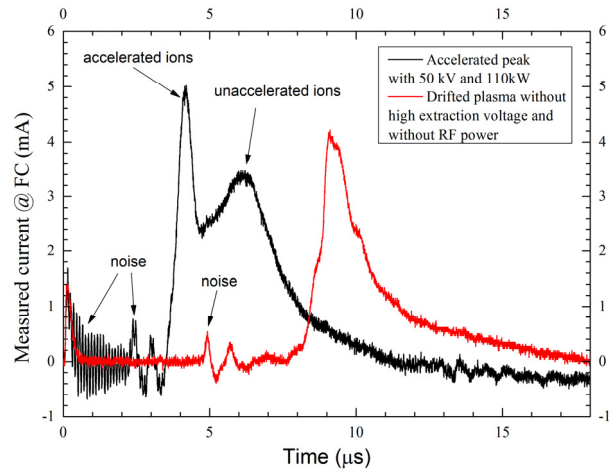

Figure 4: Measured signals of the accelerated  $C^{6+}$  ion beam, unaccelerated ion beam and drifted plasma signal from FC1.

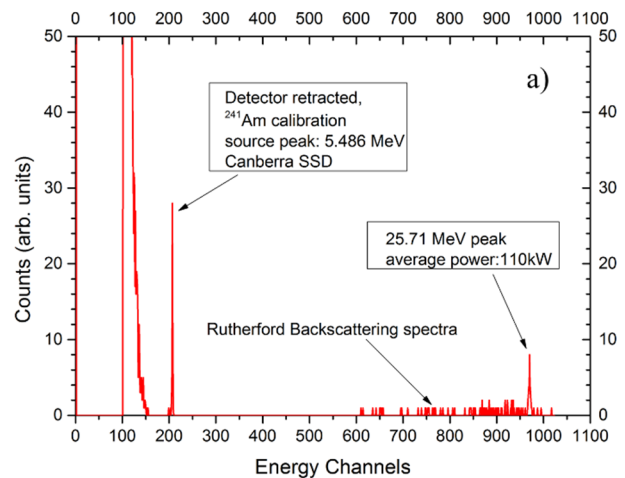

Figure 5-a: Energy channels measured by Canberra SSD. The 5.486 MeV channel is the calibration source.

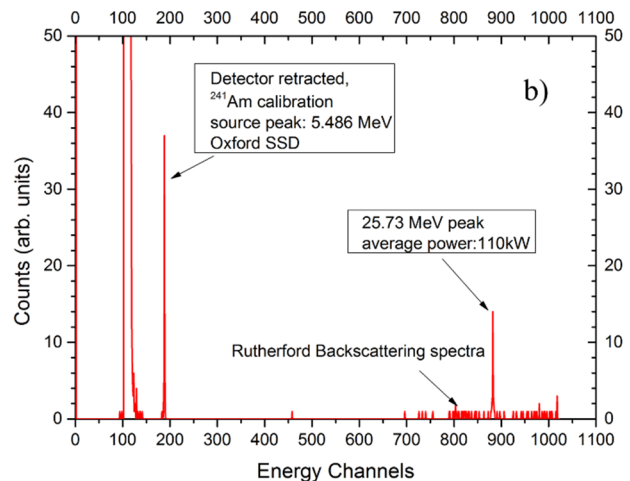

Figure 5-b: Energy channels measured by Oxford SSD.

Figure 4 shows that the total accelerated  $C^{6+}$  ions reached 5.02 mA that meet the 30% transmission of the cavity. Both Figure 5-a and Figure 5-b show that the

detected energy channels of the accelerated  $C^{6+}$  ions are confirmed as 25.7 MeV which is also meet well with the designs and the calculations. And also, the 45-degree-bending-magnet with a 50 cm deflection radius provided an 8.43 kGauss magnetic field, which implies that the ions were at an energy of 25.7 M V.

The HSC linac, as a compact and a high intensity heavy ion injector, has been proposed to accelerated and inject  $C^{6+}$  ions to a synchrotron for cancer therapy. In this study, we manufactured a 2-meter long HSC linac as a prototype hybrid cavity, and successfully commissioned high power tests for  $C^{6+}$  ion acceleration. The results of the high RF power test prove the prototype HSC linac is reliable as an injector for heavy ion cancer therapy facilities. Using the HSC, not only the existing stripper system and the multi-turn injection system can be cut down, but the magnets of the synchrotron could be reduced to two thirds or half their size because the one-turn injection could bring the size of the existing beam pipe ( $\sim 200$  mm) down to dozens

of millimeters. This will mean major cost savings for heavy ion cancer therapy facilities, and lighten the burdens for millions of patients.

## FUTURE PLAN

For further researches about HSC type linac, a 3-meter long HSC, which could accelerate high intensity  $C^{6+}$  ions up to 4 MeV/u, is being designed as a real heavy ion injector. Instead of existing HSC linac, the 4 MeV/u HSC is a high possible injector for heavy ion cancer therapy facilities. And a movable HSC-driven neutron source is also being designed using the existing HSC linac, because the cavity could accelerate proton ions up to 2.1 MeV with only 30 kW.

An image of the movable HSC-driven neutron source is shown in Figure 6.

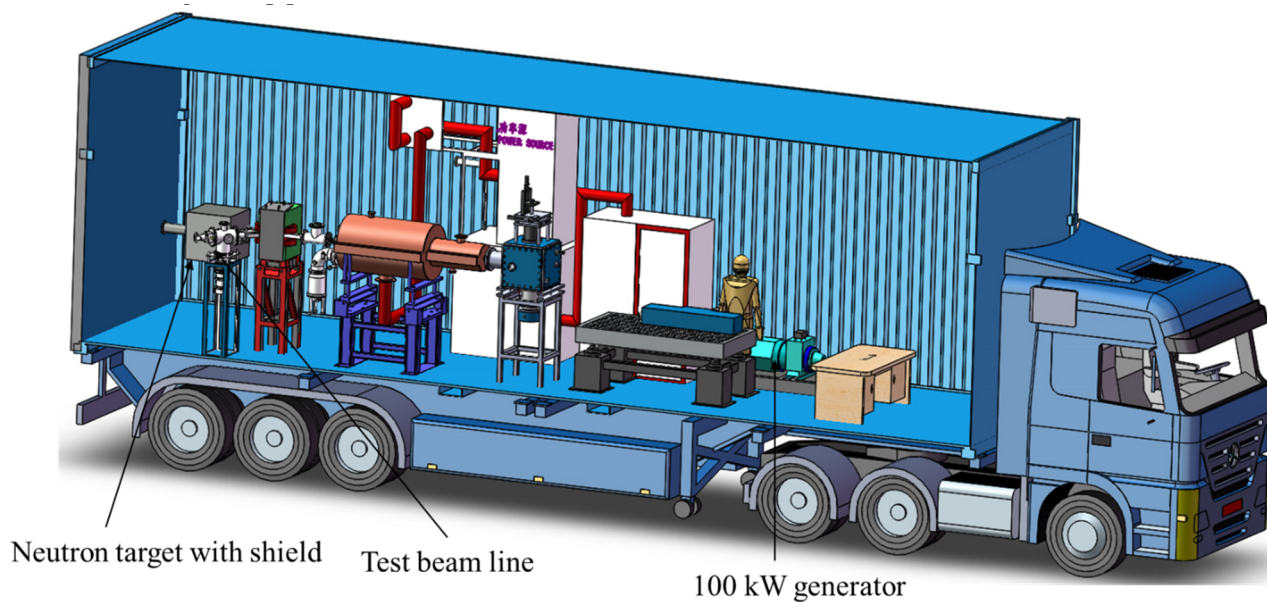

Figure 6: A truck-based HSC-driven movable neutron source.

## ACKNOWLEDGEMENT

The work was supported by the Republic of China National Science Council through Grant Nos. 11475232 and 11535016. The authors were especially indebted to T. Hattori for his enlightening comments on the platform construction. Thanks also to many collaborators for beneficial discussions and enthusiastic support in the beam operations.

## REFERENCES

- [1] L. Lu, T. Hattori, H. Zhao *et al.*, *Phys. Rev. ST Accel. Beams* 18, 11002, 2015.
- [2] E. Takada, *Nucl. Phys.* A834, 730c, 2010.
- [3] L. Lu, T. Hattori, N. Hayashizaki *et al.*, *Nucl. Instrum. Methods Phys. Res. A* 688, p.11-21, 2012.
- [4] P. N. Ostroumov, B. Mustapha, A. Barcikowski *et al.*, *Phys. Rev. ST Accel. Beams* 15, 110101, 2012.
- [5] L. Lu, T. Hattori, *et al.*, *Nucl. Instrum. Methods Phys. Res. A* 622, p.485-491, 2010.
- [6] T. Hattori, K. Sasa, M. Okamura, *et al.*, *Fusion Engineering and Design*, 32-33 p. 359-363, 1996).
- [7] Klinck, Christian.  $\alpha$ -decay of  $^{241}\text{Am}$ . Theory - A lecture course on radioactivity (University of Technology Kaiserslautern, 2010), p.123.