

EFFICIENT HEAVY ION ACCELERATION WITH IH-TYPE CAVITIES FOR HIGH CURRENT MACHINES IN THE ENERGY RANGE UP TO 11.4 MEV/U

H. Hähnel[†], U. Ratzinger, R. Tiede

Institute of Applied Physics, Goethe University Frankfurt, Germany

Abstract

We propose an efficient design for heavy ion acceleration from 1.4 to 11.4 MeV/u with a design current of 15 emA for a U^{28+} beam as a possible injector for FAIR. The proposed linac is based on IH-DTL cavities and quadrupole triplet focusing. The KONUS beam dynamics concept [1] is used to achieve high acceleration efficiency. By optimization of the transverse focusing scheme and the longitudinal bunch center motion, low emittance growth for the entire linac is achieved. Beam dynamics simulations were performed along with 3D rf simulations of all cavities. The cavities are designed for 108.408 MHz, reaching an effective shunt impedance of 100-200 M Ω /m. The overall length of the linac is just 22.6 m which is almost a third of an alternative Alvarez layout. A mechanical realization concept employing a modular tank design is presented. The proposed design is a viable option for the GSI UNILAC poststripper linac replacement, leaving free space in the UNILAC tunnel for future energy upgrades.

LAYOUT AND COMPONENTS

The whole linac structure was developed with LORASR and CST Microwave Studio. The design comprises five 108 MHz IH-DTL cavities and seven quadrupole triplet lenses [2]. The linac is divided into three mechanically rigid sections (see Fig. 1).

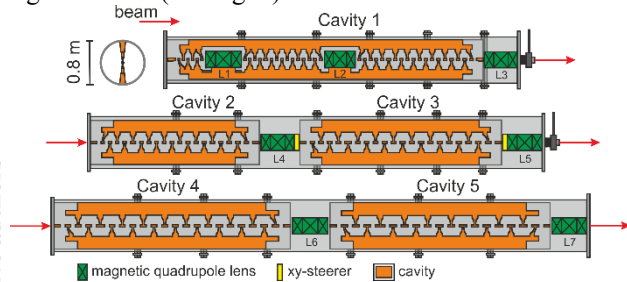

Figure 1: Layout of the IH-DTL linac.

Additionally, the cavities are divided into short modules (as shown in Fig. 2) to allow copper plating and easy alignment of the modules with drift tubes and lenses. The layout features phase probes for all lenses except L1 and L2 and beam steerers between L4 and L5 to ensure optimal beam transport. The power requirements of the cavities were estimated using CST simulations of all sections. The overall consumed power per cavity is 0.82 MW at the beginning of the linac and reaches 1.22 MW towards the end of the linac (see Table 1). At a duty factor of 0.2 % the thermal losses are in the order of 2 kW and could be managed with

simple cooling techniques. Significantly higher duty factors are also possible, but would require extensive cooling of the structures.

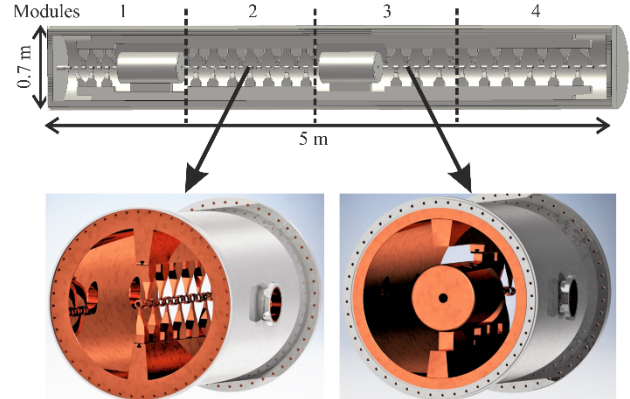

Figure 2: Mechanical design of the modular sections for the first IH-DTL cavity (courtesy of D. Bänsch)

At 108.408 MHz the IH-cavities are 0.7-0.8 m in diameter. The design limits were chosen to be state of the art values to provide a reliable and durable machine. On axis electric field in the IH-cavities is at maximum just above 11 MV/m which is a value considered safe for an IH-structure at this frequency. The quadrupole magnets are now limited by < 1.1 T at the pole tip. This provides some operational margin, since tip fields of 1.3 T are possible using current magnet technology. The average accelerating gradient of the whole linac is 3.76 MV/m.

Table 1: Cavity Properties

Cav.	L_{tot} [m]	V_{tot} [MV]	P_{tot} [MW]
1	4.9	19.6	0.8
2	2.8	17.2	1.0
3	3.6	18.7	1.2
4	3.7	18.7	1.2
5	3.9	16.8	1.2

BEAM DYNAMICS

The beam dynamics design was developed using LORASR and is based on the KONUS beam dynamics concept. The combination of a negative synchronous phase section (rebunching) followed by a longer section with a phase close to zero degrees allows for more efficient acceleration. The zero-degree section allows higher accelerating voltages and a significant reduction of radial E-field defocusing of the beam. Meanwhile the rebunching sections ensure longitudinal matching between the different sections. This way the drift length between two succeeding triplet

* Work supported by BMBF 05P15 RFRBA

[†] haehnel@iap.uni-frankfurt.de

lenses is increased. The focusing lattice for this kind of linac is FDF-DFD using quadrupole triplet lenses.

Some Remarks on KONUS Optimization

Transverse focusing was optimized by keeping a constant phase advance in the first and second half of the linac. For a quasi-periodic layout where the number of gaps in each cavity remains constant and therefore the drift length between the triplet lenses scales with the increasing velocity of the beam, a constant transverse phase advance proves to be beneficiary for low and smooth emittance growth. In case this periodicity is interrupted at some point of the linac, a change of the transverse phase advance can be introduced. The resulting beam envelopes of such constant phase advance focusing can be seen in Fig. 4.

Longitudinal beam motion was optimized for low emittance growth. To achieve good matching between the sections, the number of rebunching and zero degree accelerating gaps has to be chosen accordingly. The optimum beam orientation at the entrance of a zero-degree section is a moderately convergent beam in the longitudinal plane. Investigations of a zero-degree section without space charge show a clear minimum in rms emittance growth for the correct ellipse orientation. Figure 3 shows the optimum input orientation analysis for a zero-degree section similar to the first section of the presented IH-DTL.

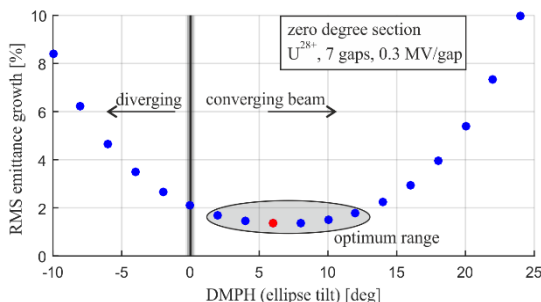

Figure 3: Rms emittance growth for different input parameters of a zero degree section.

SIMULATIONS

Final beam dynamics simulations were performed with 500.000 macroparticles. The normalized input emittances are 0.8 mm mrad (90 %) and 6.3 keV/u ns (90 %). The emittances were chosen based on simulations of the 36 MHz GSI High Current Injector HCI [3] with the new MEBT section as proposed by the authors [4]. An additional emittance growth of 50 % in the transverse planes and 200 % in the longitudinal plane was assumed for the gas stripper and charge state separator in front of the post-stripper linac. The average macropulse current of 15 mA is equivalent to 45 mA bunch current, as only every third bucket is filled by the HCI.

Results

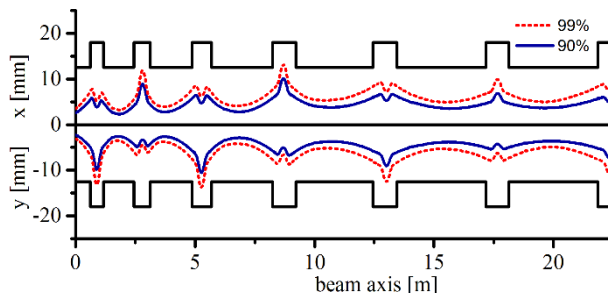

Figure 4: Transverse beam envelopes showing 99 % and 90 % of all particles.

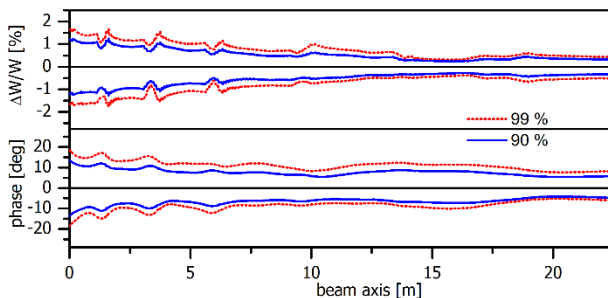

Figure 5: RMS emittance growth progression.

LORASR simulations for a 15 mA beam with 0.5 M macroparticles show low rms emittance growth of just 27.5 % / 25.8 % in the transverse planes and 10.6 % in the longitudinal plane without any particle losses. The emittance progression is relatively smooth with a steeper rise within the first five meters (see Fig. 5). The remaining sections show lower emittance growth. Figure 6 clearly shows the rebunching gaps acting at the beginning of each KONUS section as well as the smooth focusing towards the end of each zero-degree section.

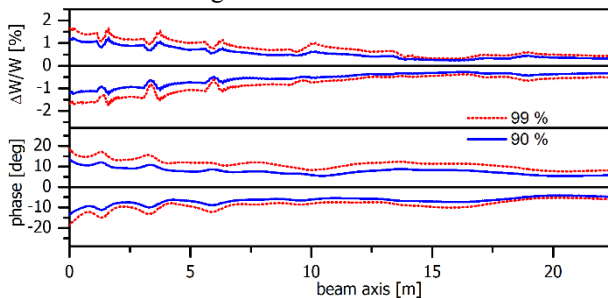

Figure 6: Longitudinal beam envelopes showing 99 % and 90 % of all particles.

The output cluster plots shown in Fig. 7 illustrate the mostly undisturbed beam quality behind the linac. In the longitudinal plane, the formation of longer particle “tails” could be prevented by careful matching of the subsequent sections.

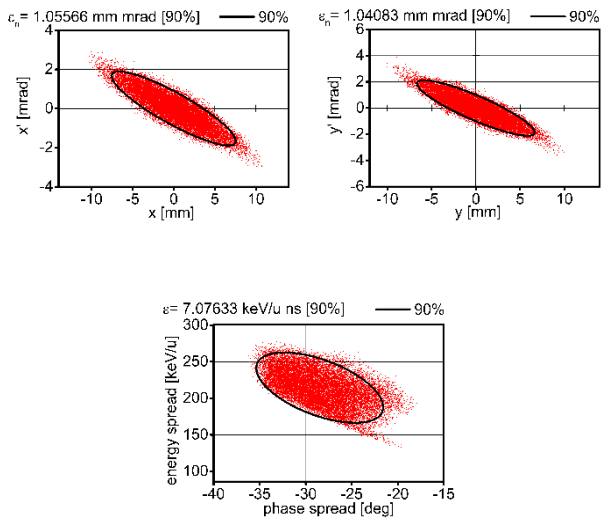

Figure 7: Output cluster plots for 15 mA, 20k macroparticles shown.

Crosscheck calculations were performed with TraceWin using the thin gap approximation. The results of both codes agree well. Beam envelopes from TraceWin calculations for 0.5 M macroparticles are shown in Fig. 8.

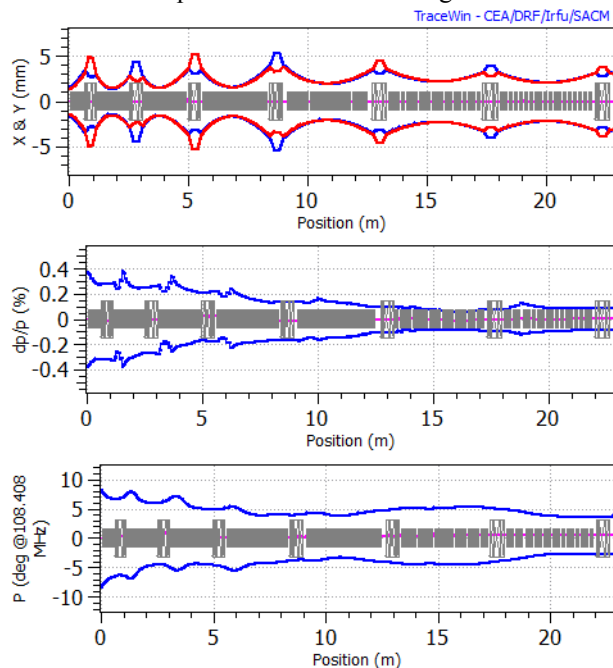

Figure 8: Rms beam envelopes from TraceWin calculations.

BENCHMARKING

The robustness of the beam dynamics design was shown during benchmarking simulations for the Alvarez replacement at GSI UNILAC. All benchmarking cases were calculated in TraceWin. The benchmark involved zero current calculations, intermediate energy (with only cavity 1 in operation) and different input emittance scenarios.

All cases could be managed with identical cavity voltages and rf phases. Modifications were only made to the

lens gradients in the linac and to lens gradients and buncher voltages in a 38 m transport section behind the linac. Longitudinal acceptance was tested with longitudinal input rms emittances of 0.6, 1.16 and 2.3 times the design emittance of the IH-DTL. Only in the latter case, minimal losses of 0.81 % were observed.

Even the case of excessively asymmetric transverse rms emittances of 0.0875/0.35 mm mrad in X-X'/Y-Y' respectively could be accelerated with minimal adjustments and only 0.78 % losses. All other cases showed 100 % transmission. The detailed results will be presented to an expert review committee in mid-October.

FUTURE POSSIBILITIES

At a total linac length of just 22.6 m there would be roughly 38 m of additional beam line available in the UNILAC tunnel if the IH-DTL was chosen as the new post-stripper linac instead of an Alvarez DTL. This would allow future upgrades of the UNILAC to energies in the range of 50 - 60 MeV/u using high gradient CH-cavities. A prototype of a 325 MHz high gradient CH-cavity has been built and tested at IAP Frankfurt [5].

CONCLUSION

We have presented an IH-DTL layout suited for the GSI UNILAC Alvarez replacement. The performance in the design case for FAIR injection is very satisfactory. The robustness of the beam dynamics concept has been confirmed during benchmarking simulations.

Further investigations of the design will involve extensive error studies to define tolerances and determine the limits of the design.

REFERENCES

- [1] U. Ratzinger, "The IH-structure and its capability to accelerate high current beams," in *Proc. PAC 1991*, 1991, pp. 567-571.
- [2] H. Hähnel, U. Ratzinger, R. Tiede, "Status of the IH-DTL poststripper linac proposal", in *GSI Scientific Report 2015*, p. 300
- [3] U. Ratzinger, "Commissioning of the new GSI high current linac and HIF related RF linac aspects," *Nucl. Instr. Meth. A*, vol. 464, no. 1-3, pp. 636-645, May 2001.
- [4] H. Hähnel, U. Ratzinger, and R. Tiede, "Proposal of a conventional matching section as an alternative to the current superlens at GSI UNILAC," in *Proc. LINAC2014*, 2014, pp. 196-198.
- [5] A. M. Almomani and U. Ratzinger, "Status of a 325 MHz high gradient CH cavity and first power test results," presented at *LINAC2016*, East Lansing, MI, USA, paper THPLR059, this conference.