

THE SUPERCONDUCTING CAVITY SYSTEM FOR KEKB

T. Tajima¹, K. Akai, E. Ezura, T. Furuya, K. Hosoyama, S. Mitsunobu
 KEK, Tsukuba, Ibaraki, 305-0801, Japan

Abstract

The superconducting cavity (SCC) for KEKB is 508 MHz single-cell cavity that has large beam pipes (22 cm and 30 cm i.d.) so that higher-order modes propagate out of the cavity and be absorbed by a lossy material. The input coupler is the TRISTAN-type coaxial one with some modifications such that dc bias voltage can be applied to avoid multipactoring during beam operation, fins to efficiently cool the outer conductor and a heater to remove condensed gases. The higher-order mode absorber is made of ferrite directly sinter-bonded on the inner surface of the copper pipe using a technique called Hot Isostatic Press (HIP). One prototype cavity was tested up to 0.57 A at TRISTAN Accumulation Ring (AR) in 1996. Then, four cavities were constructed for KEKB. One of the cavities achieved an accelerating field of 19 MV/m at a test in a vertical cryostat; this field is the world record at this frequency to our knowledge. No degradation of the field after assembly into horizontal cryostats was observed up to the available power of 300 kW that corresponds to ~12 MV/m. These four cavities were installed in KEKB tunnel and are expected to supply 6 MV in total voltage to the 1.1 A electron beam in high energy ring (HER). Since beam commissioning started in Dec. 1998, the system has been supplying 6 MV and working very smoothly without any trouble. The maximum current has been ~240 mA and power delivered to beam per cavity is ~200 kW up to the end of Feb., 1999.

1 INTRODUCTION

Based on the successful beam tests at TRISTAN Accumulation Ring (AR) in 1996 [1-4], we started construction of four superconducting cavity modules for KEKB HER from the beginning of 1997. This paper describes its construction, performance of the cavities and some of the first data on the beam operation.

2 CONSTRUCTION

Table 1 gives the parameters of the cavity module. Figure 1 shows the whole module. It has two 300 liter/s ion pumps connected to the end cones and the diameter of the end gate valves is 15 cm. Figure 2 is a picture of the four modules installed in the Nikko D11 tunnel of KEKB. Each module was installed between two quadrupole magnets. We named the cavities RA, RB, RC and RD after the names of Klystrons from left to right in the tunnel.

Table 1: Parameters of SCC module

Frequency	508.887 MHz
Gap length	243 mm
R/Q	93 Ω
Geometrical factor	251 Ω
Esp / Eacc	1.84
Hsp/Eacc	40.3 Gauss/(MV/m)
Loaded Q	6-8 x 10 ⁴
Cryostat LHe volume	290 liter

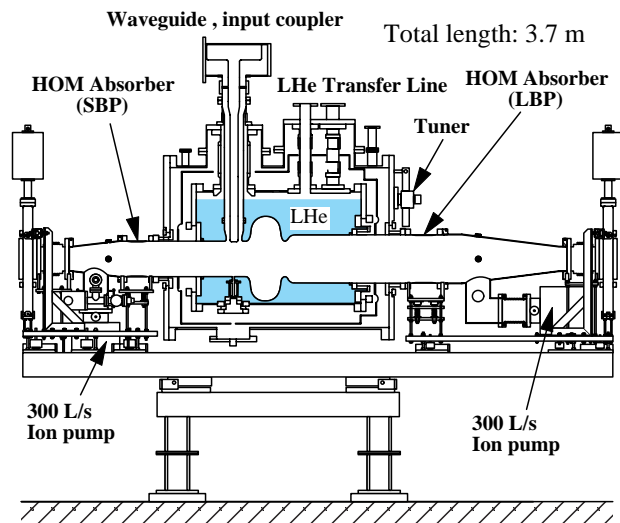

Figure 1: Superconducting cavity module for KEKB

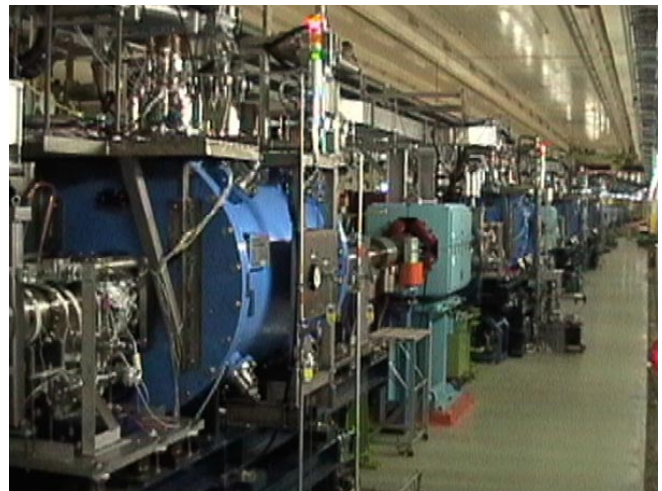

Figure 2: A picture of four SCC modules in Nikko-D11 tunnel

¹ Email: tsuyoshi.tajima@kek.jp

2.1 Fabrication of Cavities

The cavities are made of 2.5 mm thick niobium with RRR being ~200. Cavity cells were spun from sheet material and electron beam welded. The procedure of surface treatment was as follows: 1) electropolishing 80 μm , 2) degassing at 700°C for 1.5 hours and 3) electropolishing 15 μm and rinsing with 3-4 ppm ozonized water.

2.2 Assembly with Cryostat, etc.

After cavity-alone tests in a vertical cryostat, cavities were chipped-off at flange valves and transported to a class 100 clean room, vented with filtered nitrogen gas and assembled with extension pipes made of stainless steel at both ends. Then, they were assembled with cryostats, and finally end cones that had been pre-assembled with dampers and gate valves were mounted at both ends.

3 PERFORMANCE OF THE CAVITIES

Figure 3 shows unloaded quality factor, Q_0 , of the four cavities as a function of accelerating field. In the figures, open circles are the results of cavity themselves measured in a vertical cryostat. Open squares are the results of bench tests after fully equipped with horizontal cryostat and other parts before installation in the tunnel. Solid triangles and solid circles are the results measured in the tunnel on Nov. 27, 1998, before first operation and on Jan. 13, 1999, before second operation.

Although the designed voltage for operation is 1.5 MV or 6 MV/m per cavity, we set our target at 10 MV/m and $Q_0 \geq 1 \times 10^9$ to have enough margin for stable operation and in case of the operation with fewer modules. Cavity RA could not reach this target due to a defect on the equator. After the defect was ground off, the cavity showed nearly 10 MV/m. Cavity RB surpassed our record on vertical tests (15 MV/m) [5], reaching 19 MV/m. Using the numbers given in Table 1, one can obtain surface peak field of 35 MV/m and magnetic field of 750 Gauss. To our knowledge, this is the highest value ever reached with 500 MHz range cavities at 4.2 K. Cavity RC degraded during first vertical test due possibly to some damage created by discharge.

As to the results after full assembly and installation, the remarkable point is that very little degradation from cavity-alone tests occurred compared to the results of TRISTAN cavities [6]. Note that the highest fields are not marked in Fig. 3 since it is difficult to measure Q_0 . Cavity RA got even better in Q_0 for some reason. As for cavity RB, we did not try to go much higher because the field is more than enough for operation and due to available power.

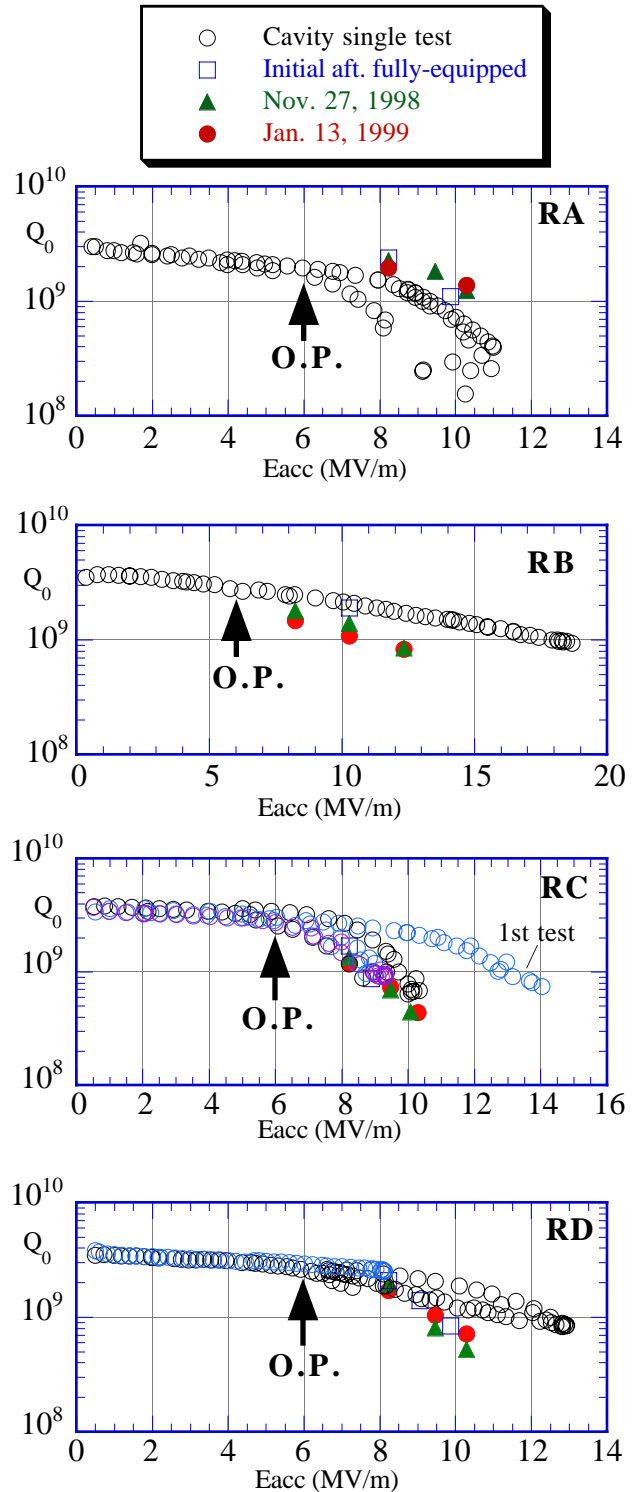

Figure 3: Unloaded Q vs. accelerating field of all the cavities. O.P. stands for operation point.

4 BEAM OPERATION

4.1 Conditioning

Before cooling down the cavities, we condition the input coupler up to 300 kW with perfect reflection condition, and up to 200 kW with dc bias voltages applied on the

inner conductor up to ± 2 kV. Normally, it takes one day with one operator for each module.

After the LHe vessel is filled up to 90 %, we try to raise coupler power up to 300 kW in off-resonance condition, and raise the cavity voltage, V_c , up to about 3 MV that corresponds to 12 MV/m or till breakdown occurs. Then, we shift phase of cavity up to $\pm 30^\circ$ so that the field profile in the coupler changes to condition the less conditioned parts of the coupler. When we see some degradation on the attainable field, we apply pulsed power conditioning. It takes only a few hours at most to recover. This also takes about one day.

Finally, we measure Q_0 at certain cavity voltages, e.g. at 2.0, 2.5 MV, with LHe consumption rate. This takes about 6 hours, depending on how many data we want to take.

Table 2 summarizes the present status of the modules.

Table 2 : Present performance of the modules
Mar. 18-19, 1999

Cavity	RA	RB	RC	RD
$Q_0 @ 2MV (x10^9)$	2.1	2.0	1.3	1.4
Eacc,max (MV/m)	12.3	13.0	10.7	11.3
Static loss (W)	31	77 ¹⁾	32	32

¹⁾Due to insufficient insulation vacuum caused by leak

4.2 Vacuum

Figure 4 shows the time evolution of pressure in the cavities and at the adjacent beam ducts. Considering the importance of making the amount of gas flowing into the cavity as small as possible for stable operation, we installed five 400 liter/s NEG pumps and one 300 liter/s ion pump on the duct between each module. The effective pumping speed at the neighboring ducts is ~ 77 liter/s-m [7]. As one can see in Fig. 4, the base pressure of the ducts is normally 0.6 to 0.7 nTorr at present. It is certain that this good vacuum is contributing to the stable operation.

Figure 5 shows the pressure increase with current. The pressure goes up linearly with current. Cavity RD is showing relatively higher pressure as seen in Fig. 5 for some reason, although the slope is same as others. The extrapolated pressure at 1.1 A is 5.7-6.8 nTorr. Compared with the last test in TRISTAN AR where the pressure went up to ~ 10 nTorr with 400 mA, this looks promising. However, taking into account that the beam loss will be much higher with shorter bunch length and pressure might increase non-linearly, we should keep watching it very carefully and it will be important to find appropriate indicators on the condition of trips in terms of pressure or amount of gas condensed on the cold surface, although it is of course desirable if there will be few trips in the future as it is now.

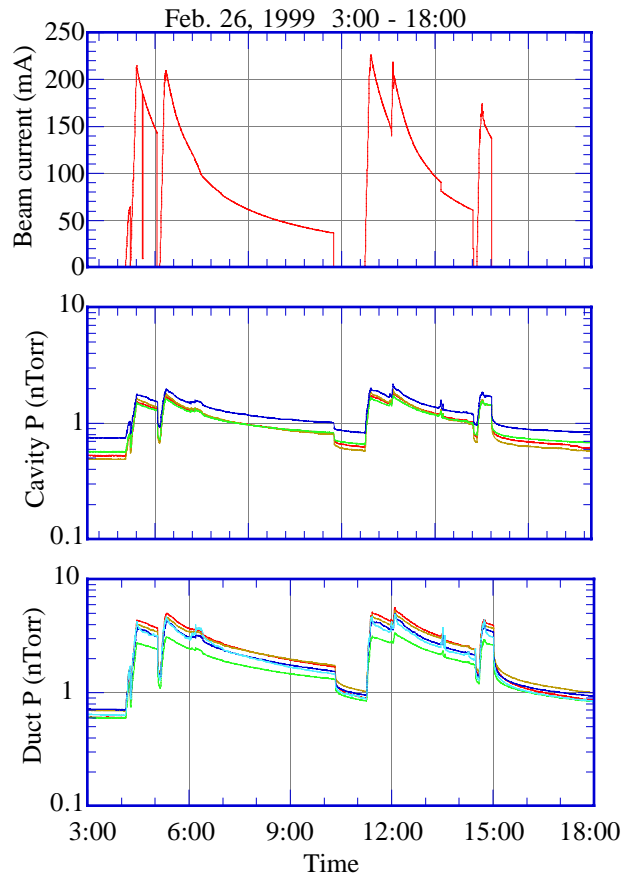

Figure 4 : Typical trend of pressure during beam operation

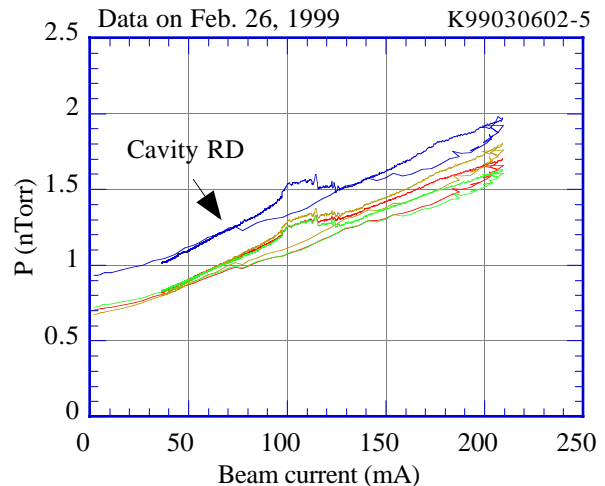

Figure 5 : Pressure at SCC versus beam current.

4.3 HOM Dampers

HOM dampers are made of ferrite [8] and tested up to 5 kW and 7 kW for SBP and LBP, respectively, with a 508 MHz coaxial line, then baked at 150°C for about one month to reduce outgassing rate. The expected rate after baking is less than 1.5×10^{-11} Torr-liter/s-cm² at room temperature, which corresponds to a total outgassing rate of the dampers being 5.2×10^{-8} Torr-liter/s.

The damper has 3/8" or 1/2" o.d. copper cooling pipe press-inserted on the outer layer made of oxygen free copper. Each cavity module has its own cooling unit for dampers and its capacity is 11.6 kW at 20°C. The normal operating condition is 5 liters/min at 23°C. The expected total power to be absorbed at 1.1 A with 5000 bunches is about 5 kW.

Figure 6 shows the power calculated from the difference of inlet and outlet water temperature and the flow rate as a function of beam current. This data was taken when the beam is coasting in order to minimize the inaccuracy due to delay of thermal response compared to the change of current. The fluctuation of the signal is caused by the fluctuation of inlet temperature to regulate the temperature. It relatively widens at lower temperature due to small temperature difference between inlet and outlet water. If one takes the lower envelope of each curve, he can obtain correct values since power should not be negative at zero current. All the data are shifted so that the power becomes zero with no current.

This data was taken with 8 trains of 40 bunches. The bunch separation was 5 RF buckets. If the loss factor is constant, i.e. bunch length does not change, and the number of bunches is unchanged during the coasting, power should increase quadratically with current as shown in the formula below. One can see this dependence in Fig. 6.

Figure 7 shows the loss factor, k , calculated with the following formula and the measured power, P_{loss} , together with a prediction drawn by a solid line.

$$k [V/pC] = \frac{P_{loss} [kW] \cdot N_b \cdot f_r [kHz]}{\{I_b [mA]\}^2} \quad (1)$$

where N_b and f_r are the number of bunches and the revolution frequency, respectively. The error bar of the measured value corresponds to the distribution of all the four modules. As seen in Fig. 7, the measured data were slightly lower than the calculation at bunch length of 6 mm. Whether it will stay lower than the calculation or will go higher than that is not clear yet, although the results of a beam test carried out at TRISTAN showed that it tends to become higher than calculation with shorter bunches [9].

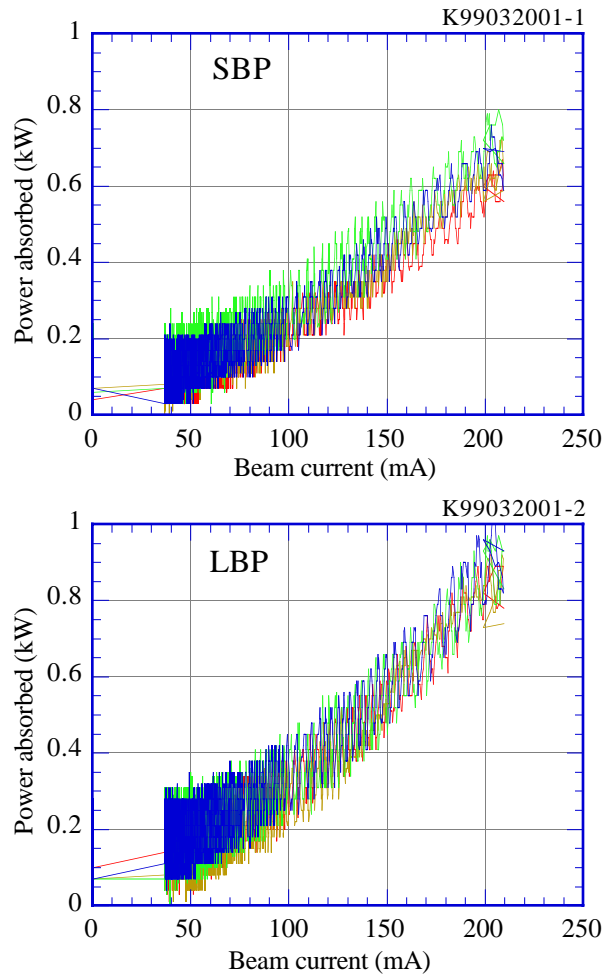

Figure 6 : Power absorbed at the dampers S and L versus beam current. Data of 4 modules are put in the same figure. Lower envelopes of the curves give correct values. Fluctuation is due to the temperature of inlet water being regulated.

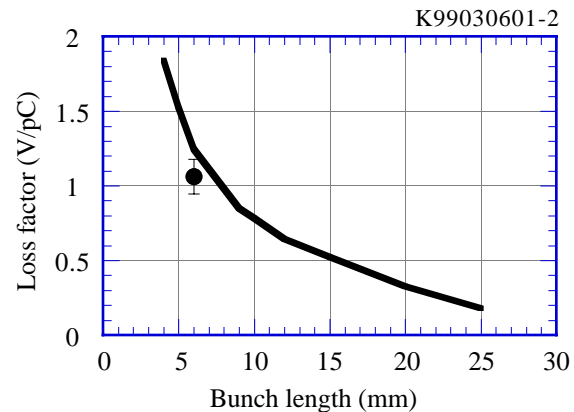

Figure 7 : Loss factor versus bunch length. The solid line is the sum of ABCI calculation for the cavity structure with cones without absorber and analytic calculation [10] for the absorber. Error bar denotes the difference between modules.

4.4 Cryogenic System

We are reusing the cryogenic system constructed for TRISTAN [11] except that new transfer lines were developed to reduce heat loss and to add more flexibility in connecting with cavity modules. The system has been running smoothly, thanks to the skilled operators.

4.5 RF System

Based on the successful test at the TRISTAN AR [4], direct RF feedback has been implemented [12] and used, contributing to stable operation.

4.6 Trips

So far, up to the end of Feb., 1999, there have been only two trips since the commissioning started in Dec. 1998. These trips were caused by breakdown of a cavity but we could not identify the cause because it did not repeat. In our past experiences, trips are strongly related to the condensed gases on the input coupler or cavity near the coupler. Therefore, we will be watching the behavior of pressures at the cavity and at the adjacent beam ducts.

5 SCHEDULE FOR NEXT MODULES

We are planning to install another four modules to increase voltage and beam current to achieve 1.1 A. Table 3 shows a tentative schedule for the construction of the next four cavity modules. In our present plan, four cavities will be installed in the tunnel in August, 2000.

Table 3 : Schedule for the next 4 modules

Activity Name	2000							
	1	2	3	4	5	6	7	8
Manufacture of 4 cavities and cryostats	◆							
Bench tests with vertical cryostat		◆		◆				
Full assembly with other parts			◆		◆			
Bench tests with horizontal cryostat				◆		◆		
Installation in the tunnel							◆	◆
LHe transfer line install.								◆

6 SUMMARY

We finished construction and installation of four superconducting cavity modules for KEKB-HER by the fall of 1998. Since the beam commissioning started in Dec. 1998, all the modules have been operated at 1.5 MV(6 MV/m) each or 6 MV in total. Up to the end of Feb., 1999, maximum current is about 240 mA and

maximum power delivered to beam is about 200 kW per cavity.

The system has been running very smoothly with very few trips so far. As beam current gets higher and bunch length gets shorter, some dedicated studies such as beam related loss and HOM searches will be planned.

7 ACKNOWLEDGMENT

The authors are indebted to K.Kanazawa, Y.Suetsugu and their co-workers for design and installation of adjacent vacuum ducts and components, H.Nakanishi for waveguide architecture, S.Isagawa, S.Yoshimoto and their co-workers for maintaining Klystrons, K.Hara, A.Kabe, Y.Kojima, Y.Morita, H.Nakai and their co-workers for constructing cryogenic system and its maintenance. They also would like to thank Y.Kijima, T.Murai, S.Takagi and their co-workers of Mitsubishi Electric Company for their devotion to the construction. Finally, they are grateful to Professors S.Kurokawa, K.Takata, Y.Yamazaki and M. Kihara for their continuous encouragement.

8 REFERENCES

- [1] T. Furuya et al.; Proc. PAC97, Vancouver, B.C., Canada, May 12-16, 1997. p. 3087
- [2] T.Tajima et al.; *ibid* p. 3092
- [3] S. Mitsunobu et al.; *ibid* p. 2908
- [4] K.Akai et al.; 11th symposium on Accelerator Technology and Science, Hyogo, Japan, Oct. 21-23, 1997. KEK Preprint 97-137.
- [5] T.Tajima et al.; 5th Workshop on RF Superconductivity, DESY, Hamburg, Germany, August 19-24,1991. KEK Preprint 91-193
- [6] S.Noguchi et al.; EPAC '94 London, UK ; 27 Jun - 1 Jul 1994. KEK Preprint 94-43.
- [7] Y.Suetsugu: private communication.
- [8] T.Tajima et al.; Proc. PAC95 p. 1620
- [9] T.Tajima et al.; KEK Report '96-7 (1996).
- [10] Code for analytic calculation was written by N.Akasaka.
- [11] K.Hosoyama et al.; Proc. 4th Workshop on RF Superconductivity, KEK, Tsukuba, Japan, Aug. 14-18, 1989, p. 755, KEK Report 89-21.
- [12] K.Akai et al.; EPAC98, Stockholm, June 22-26, 1998. KEK Preprint 98-82.