

# NOVOSIBIRSK FREE ELECTRON LASER: OPERATION AND SECOND STAGE COMMISSIONING

N.A. Vinokurov, E.N. Dementyev, B.A. Dovzhenko, N.G. Gavrilov, B.A. Knyazev, E.I. Kolobanov, V.V. Kubarev, G.N. Kulipanov, A.N. Matveenko, L.E. Medvedev, S.V. Miginsky, L.A. Mironenko, V.K. Ovchar, V.M. Popik, T.V. Salikova, M.A. Scheglov, S.S. Serednyakov, O.A. Shevchenko, A.N. Skrinsky, V.G. Tcheskidov, Yu.F. Tokarev, P.D. Vobly, Budker INP, Novosibirsk, Russia

## Abstract

The first stage of Novosibirsk high power free electron laser (FEL) is in operation since 2003. It is based on the normal conducting CW energy recovery linac (ERL). Now the FEL provides electromagnetic radiation in the wavelength range 120 - 230 micron. The maximum average power is 400 W. The minimum measured linewidth is 0.3%, which is close to the Fourier-transform limit. Four user stations are in operation now. Two other are in progress. Novosibirsk ERL has rather complicated magnetic system. One orbit for 11-MeV energy with terahertz FEL lies in vertical plane.

Other four orbits lie in the horizontal plane. The beam is directed to these orbits by switching on of two round magnets. In this case electrons pass four times through accelerating RF cavities, obtaining 40-MeV energy. Then, (at fourth orbit) the beam is used in FEL, and then is decelerated four times.

At the second orbit (20 MeV) we have bypass with third FEL. When magnets of bypass are switched on, the beam passes through this FEL. The length of bypass is chosen to provide the delay, which necessary to have deceleration instead of acceleration at the third passage through accelerating cavities.

Now two of four horizontal orbits are assembled and commissioned. The electron beam was accelerated twice and then decelerated down to low injection energy. First multi-orbit ERL operation was demonstrated successfully.

## INTRODUCTION

A source of terahertz radiation was commissioned in Novosibirsk in 2003 [1]. It is CW FEL based on an accelerator-recuperator, or an energy recovery linac (ERL). It differs from other ERL-based FELs [2, 3] in the low frequency non-superconducting RF cavities and longer wavelength operation range. Full-scale Novosibirsk free electron laser facility is to be based on the four-orbit 40 MeV electron accelerator-recuperator (see Fig. 1). It is to generate radiation in the range from 5 micrometer to 0.24 mm [4, 5].

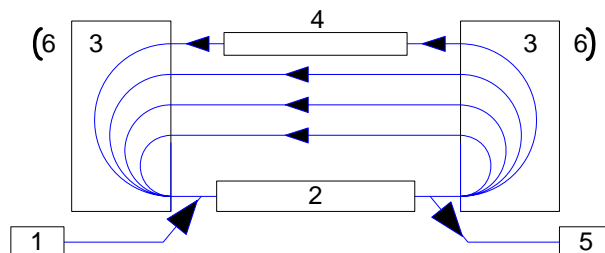

Figure 1: Scheme of the accelerator-recuperator based FEL. 1 - injector, 2 - accelerating RF structure, 3 - 180-degree bends, 4 - undulator, 5 - beam dump, 6 - mirrors of the optical resonator.

## THE FIRST STAGE OF NOVOSIBIRSK ERL

The first stage of the Novosibirsk free electron laser (Fig. 2.), based on the energy-recovery linac, generates coherent radiation tunable in the range 110-240 micron as a continuous train of 40-100 ps pulses at the repetition rate of 2.8-22.5 MHz. Maximum average output power is 500 W, the peak power is more than 1 MW [6,7].

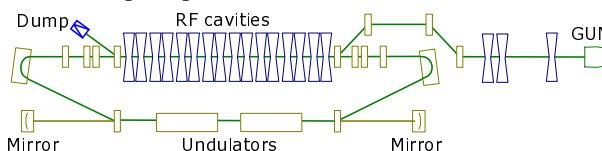

Figure 2: Scheme of the Novosibirsk terahertz free electron laser.

The first stage contains the full-scale 180-MHz RF system and accelerator structure, but has only one orbit. Main parameters of the ERL are summarized in Table 1.

Table 1: Parameters of the first stage of Novosibirsk ERL.

Beam energy, MeV	12
Maximum average electron current, mA	30
RF frequency, MHz	180.4
Bunch repetition rate, MHz	22.5
Bunch length, ps	100
Normalized emittance, mm-mrad	30
Charge per bunch, nC	1.5
RF cavities Q factor	$4 \cdot 10^4$

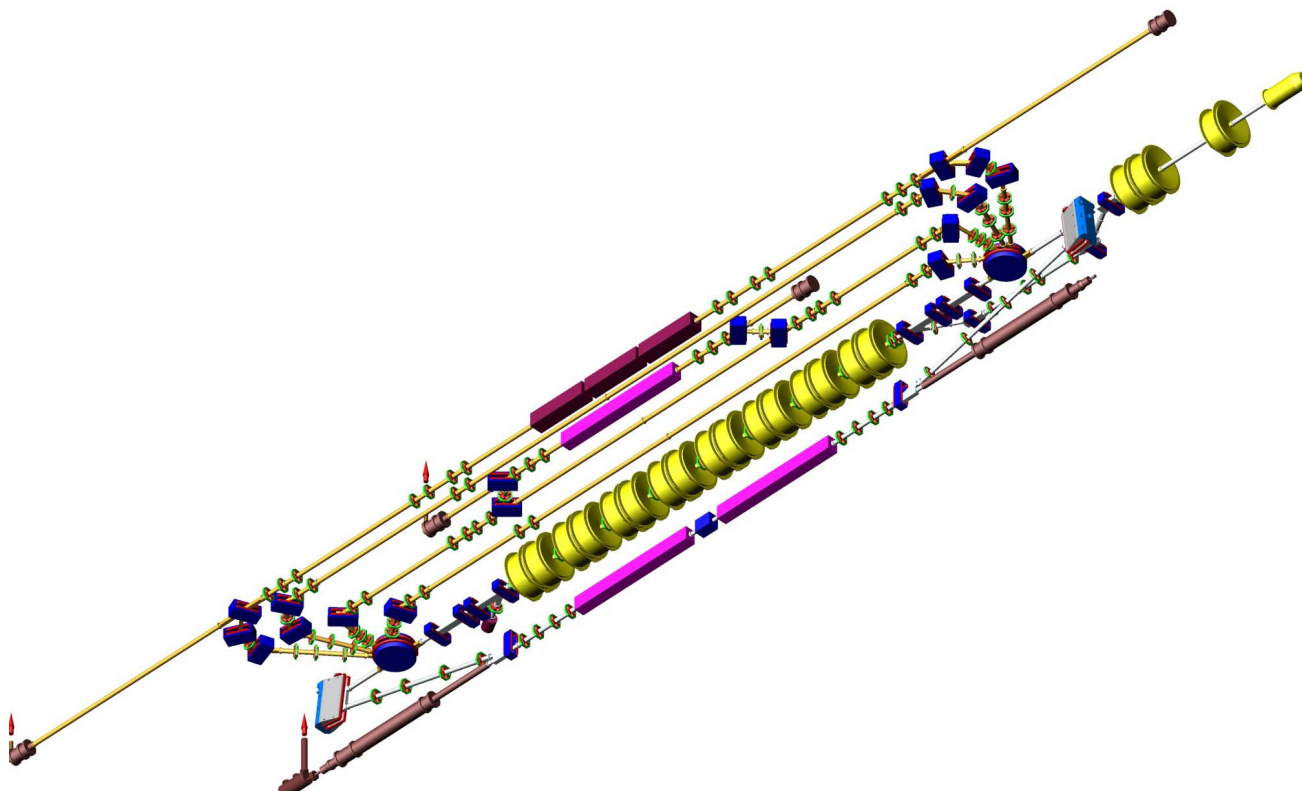

Figure 3: The second stage of the Novosibirsk high power FEL (bottom view).

### THE DESIGN OF THE ERL SECOND STAGE

The design and manufacturing of the full-scale four-turn ERL is underway. An artistic view of the machine is shown in Fig. 3. The orbit of the first stage with the terahertz FEL lies in the vertical plane. The new four turns are in the horizontal one. One FEL is installed at the fourth orbit (40 MeV energy), and the second one at the bypass of the second orbit (20 MeV energy).

Some distinguished features of Novosibirsk multi-turn ERL are described below.

#### The Orbit Geometry

It is critical in the realization of the bends that there is one magnet, common for all the passes, which performs separation of the orbits, and there are magnets, different for different orbits, which add the bend to 180 degrees. In the first two paths the rest bending system consists of one magnet. To start with, we'll consider the geometry of the 180° bend, consisting of a round magnet and one bending magnet of the same bend radius. The bend scheme [8] is shown in Fig. 4, where  $R$  is bend radius of the magnets,  $a$  - radius of the round magnet,  $d$  - distance between the axis of the common path and the center of the round magnet,  $h$  - height of the path,  $(\pi - \alpha)$  - angle of a bend by the first magnet. Simple geometrical consideration leads to the expression for the bend in the round magnet with homogeneous field

$$\tan \frac{\alpha}{2} = \frac{R - d}{\sqrt{a^2 - d^2}}. \quad (1)$$

It worth noting, that due to axial symmetry round magnet has some advantages. Due to the angular momentum conservation its optical properties are simple. In particular, the second-order aberrations are suppressed. Moreover, as the magnet rotation around the symmetry axis does not matter, the magnet alignment is simple. The separation of trajectories with different energies is rather homogeneous, as the magnetic length increases with energy.

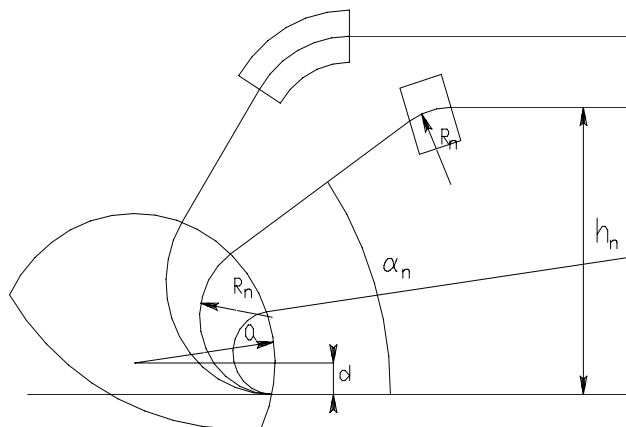

Figure 4: Scheme of the 180° bends with two magnets.

The distance between the round magnet and the second one is  $l_0 = (h - 2R) / \sin \alpha$ . Then the total length of the orbit with the bend is

$$S = 2L + 2 \left( \pi R + (h - 2R) \tan \frac{\alpha}{2} \right), \quad (2)$$

where  $L$  is the length of the common straight-line section. One can see that the first term  $2L$  will be the same for all the orbits, therefore the further consideration will be devoted only to the terms connected with the bends  $s = S - 2L$ . Substituting expression for  $\tan \frac{\alpha}{2}$  (1) to Eq. (2), one has:

$$s = 2\pi R + 2 \frac{(h-2R)(R-d)}{\sqrt{a^2-d^2}}. \quad (3)$$

Until now we were considering only one orbit. Now we will compare the different orbits. As the particle energy  $E$  increases linearly with the number of orbit and the bend radius in the magnet is proportional to the momentum  $p \approx E/c$ , the bend radius at the  $n$ -th pass is

$$R_n = (n + \delta)\Delta R. \quad (4)$$

$\delta$  appeared due to the non-zero initial momentum ( $\delta = p_0/\Delta p$ , where  $p_0$  is the injection momentum,  $\Delta p$  - the momentum gain per pass). For the sake of convenience we shall consider the long straight parts of orbits to be located at an equal distance  $\Delta h$  from each other. Then the height of the  $n$ -th path is:

$$h_n = h_0 + n\Delta h \quad (5)$$

Substituting expressions for  $R_n$  and  $h_n$  to Eq. (3), one has:

$$s_n = 2\pi(n + \delta)\Delta R + 2 \frac{(h_0 + n\Delta h - 2(n + \delta)\Delta R)((n + \delta)\Delta R - d)}{\sqrt{a^2 - d^2}}. \quad (6)$$

The difference of the lengths of passes  $n+1$  and  $n$ :

$$\Delta s = s_{n+1} - s_n = 2\pi\Delta R + 2 \frac{(d - 2R_n)(2\Delta R - \Delta h) - \Delta R(2R_{n+1} - h_{n+1})}{\sqrt{a^2 - d^2}}. \quad (7)$$

The particles to come in the same phase at each pass, the difference between passes  $n+1$  and  $n$  should be equal to  $q\lambda$  ( $q$  is integer,  $\lambda$  is the wave length of accelerating RF).

Then from Eq. (7) we obtain the necessary relation between  $\Delta h$  and  $\Delta R$

$$\Delta h = 2\Delta R. \quad (8)$$

Taking into account Eq. (4), (5), (7), and (8), the condition  $\Delta s = q\lambda$  can be represented in the form

$$\Delta s = \Delta h \left( \pi + \frac{h_0 - \Delta h \delta}{\sqrt{a^2 - d^2}} \right) = q\lambda. \quad (9)$$

Resolving Eq. (9) for  $\sqrt{a^2 - d^2}$ , we have:

$$\sqrt{a^2 - d^2} = \frac{h_0 - \Delta h \delta}{q\lambda/\Delta h - \pi}. \quad (10)$$

For our ERL the momentum increase per one pass through the accelerating resonators  $\Delta pc$  is 9 MeV and

the injection momentum  $p_0 c$  is 1.5 MeV, then  $\delta = 1/6$ .

Choosing the  $\Delta h$  and  $h_0$  to have enough room between parallel straight-line sections, and the angle  $\alpha_1$  for the first orbit, one can find  $R_n$ ,  $a$ ,  $\alpha_n$  and  $l_{0n}$ . Thus, we calculated the whole geometry of the 180-degree bends. To meet the limitation by the accelerator hall width (6 m) and to have reasonable round magnet size  $a$ , we had chosen  $q = 2$ .

To provide deceleration after the fourth orbit the length of the last one is different (about 0.7 m longer).

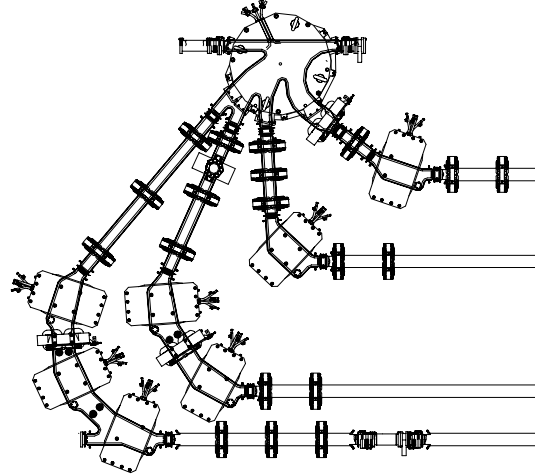

Figure 5: Magnets and vacuum chamber of bends.



Figure 6: The bends are hanged on the ceiling. Round magnet is at the top left corner, the old terahertz FEL magnetic system is at down-left. Elements of the optical resonator for the second-turn FEL are yet at the floor (down-right corner).

At the second straight line section (about 20 MeV energy) the bypass with the far infrared FEL is installed (see Fig. 3). The bypass also provides about 0.7 m lengthening of the second orbit. Therefore, when the bypass magnets are switched on, the deceleration of beam

take place at the third passing through the accelerating system, and after that electrons come to the first orbit and, after the second deceleration, to the beam dump.

### The Mechanical Design

The bends are shown in Fig. 5 and 6. All 180-degree bends are achromatic. To reduce sensitivity to the power supply ripples, all magnets are connected in series. To simplify the mechanical design, all non-round (small) magnets are similar and parallel-edge (see Fig. 7).

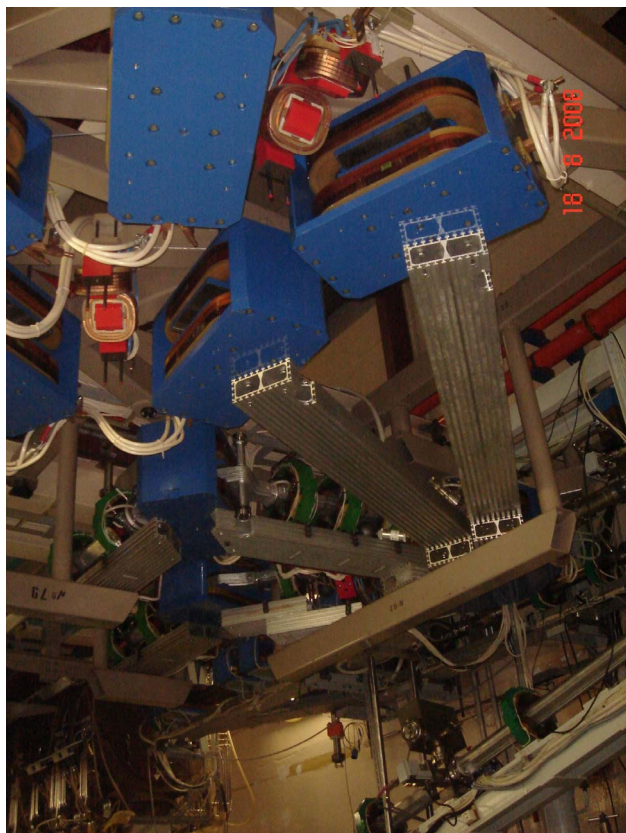

Figure 7: Small bending magnets of third and fourth tracks. Vacuum chambers are not installed yet. Top halves of quadrupoles between bending magnets are seen.

The magnetic field in the small magnets of the first track is about twice lower, than in the round magnets. The magnetic field in other small magnets is twice more, than in the round magnets. It changes slightly the orbit distances from  $\Delta h$  (at fixed orbit lengths), but safe space for focusing quadrupoles and reduce the magnet weight.

Water-cooled vacuum chambers are made from aluminium.

The bypass entrance is shown in Fig. 8. Its magnetic system contains four bending magnets, quadrupoles, and electromagnetic undulator.

### CURRENT STATUS

Two first orbits including bypass and undulator were assembled last year. The circulation (two accelerations and two decelerations) of average current 9 mA was achieved. Typical four-turn signal from one of BPM

buttons is shown in Fig. 9. This BPM is situated at the accelerating straight section.

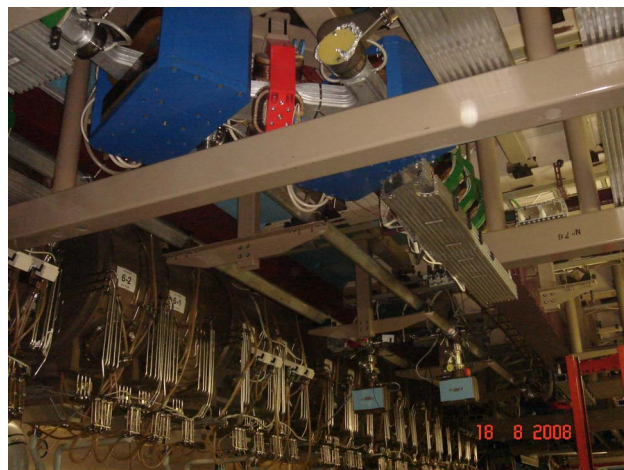

Figure 8: Bending magnets at the entrance of bypass (top). Accelerating RF cavities, vacuum chambers of two first tracks, and undulator (blue) are seen at the lower part of the picture.

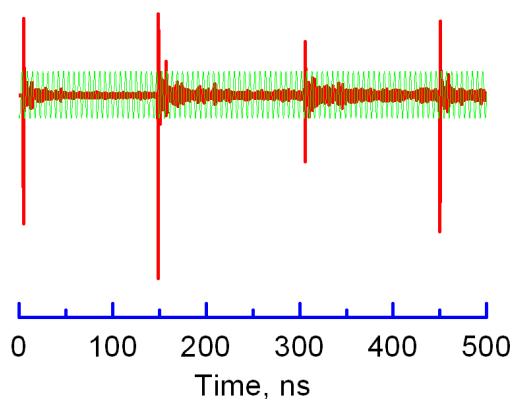

Figure 9: BPM signal of single electron bunch. The sinusoidal RF signal (green) makes possible direct measurement of the orbit lengths.

### REFERENCES

- [1] E. A. Antokhin et al. NIM A528 (2004) p.15-18.
- [2] G.R. Neil et al. Phys. Rev. Lett. 84 (2000), p. 662.
- [3] E.J. Minehara. NIM A483, p. 8, 2002.
- [4] N.G. Gavrilov et al. IEEE J. Quantum Electron., QE-27, p. 2626, 1991.
- [5] V.P.Bolotin et al. Proc. of FEL-2000, Durham, USA, p. II-37 (2000).
- [6] V.P. Bolotin et al., Status of the Novosibirsk ERL, NIM A 557, (2006), p.23-27.
- [7] E.A.Antokhin et al., Problems of Atomic Science and Technology, p.3-5, №1, 2004.
- [8] E.A.Antokhin et al., Proc. of Fourth Asian symposium on free electron lasers (AFEL'99) and Korea – Russia joint seminar on high-power FELs, KAERI, 2000. – P. 221-226.