

## UPGRADE OF FEEDBACK LOOPS IN ACCELERATING CAVITIES OF THE U70

A. Markin, V. Chubrik, S. Ivanov, O. Lebedev, I. Sulygin

Institute for High Energy Physics (IHEP), Protvino, Moscow Region, 142281, Russia

### Abstract

The entire accelerating system of the U70 proton synchrotron of IHEP-Protvino comprises 40 identical ferrite-loaded cavities yielding 10 kV per gap max [1]. To ensure control over amplitude and phase of RF voltage across the each accelerating gap, two feedback loops per cavity are employed — for automatic voltage amplitude (shortly, AVC) and automatic resonant frequency (AFC) controls. Attaining higher intensity and better quality of beam in the U70 depends upon operational performance of the AVC and AFC circuits in question. To this end, these crucial sub-systems were recently renovated so as to implement the up-to-date hardware and electrical-circuit solutions. The paper contains a brief technical specification of the thus updated feedbacks. Experience acquired during their turning on and beam-testing results are presented.

### AVC CIRCUIT

Block diagram of the AVC circuit in RF system of the U70 is shown in Fig. 1. Its performance data is specified in Table 1.

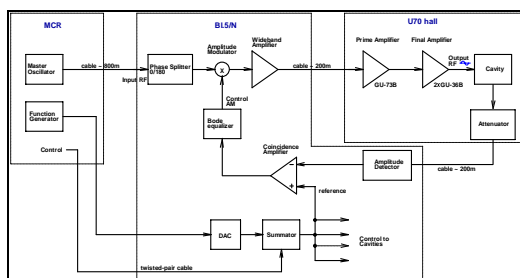

Figure 1: Block diagram of the AVC circuit.

Table 1: Performance data of the AVC circuit

Bandwidth of RF amplitude modulator	$\geq 1-30$	MHz
Group delay over 2.5–6.1 MHz band	$\leq 10$	ns
Dynamic range	$\geq 50$	
Voltage tuning range	1–10	kV
Accuracy of RF voltage DC amplitude setting	1	%
Bandwidth of stabilizing feedback @ -3 dB	$\geq 200$	Hz
Bandwidth of regulation	$\geq 40$	kHz
Max fractional regulation over-shoot	$\leq 10$	%
Scaling factor w. r. t. voltage reference	10/4	kV/V
SNR through control path	$> 1000$	

Sub-systems to follow were subjected to the upgrade:

1. an amplitude detector (AD),
2. an amplitude modulator (AM),
3. a comparing amplifier unit, and
4. a dedicated network to correct amplitude- and phase-frequency transfer functions.

Functionally, the AD is used for measurement of and visual control over amplitude of RF voltage across cavity gap. Its signals are acquired by an interlock system as well. A capacitive divider unit shunting the gap is used as a voltage sensor.

The AD itself employs a wideband operational amplifier chip AD8055 with a germanium diode D311 in the feedback path. Such a circuit solution resulted in a detector with a high linearity over a wide range of amplitudes. The dead-zone is about 10 mV given an operational voltage level of 4 V.

The AM unit is based on a multiplier device AD834 with a 60 dB wide range of dynamic regulation. A differential amplifier AD8130 is implemented at exit from a high-frequency section of the AVC path. It was found to be best compliant to a symmetric RF signal available at exit from the AD834 multiplier.

The AVC circuit embeds a few time-lagging (inertial) sections — a cavity, an AD, and lengthy cable routes. Their cutoff frequencies differ by a decade, at most. To this end, to avoid self-excitation at large open-loop gains, measures to correct for amplitude- and phase-frequency transfer functions are required. Electrical circuit of the relevant corrector unit is drawn in Fig. 2.

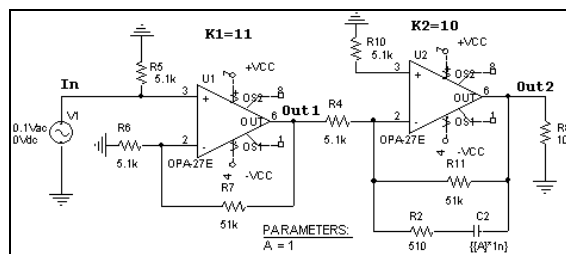

Figure 2: Electrical circuit of correcting network.

Fig. 3 shows outcomes of the network modeling for a set of various capacitance values C2.

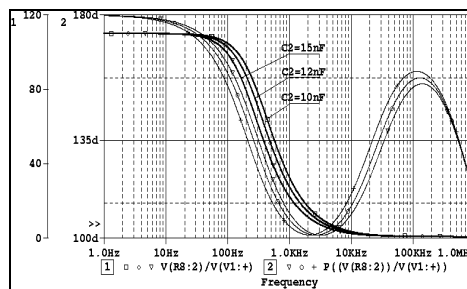

Figure 3: Amplitude- and phase-frequency transfer functions of correcting network.

DC gain that is responsible for accuracy of tying-in gap voltage amplitude to external voltage reference is equal to 110, yielding the residual locking accuracy  $< 1\%$ . The

circuit bandwidth is 200–300 Hz which is set by a capacitance inside the correcting network.

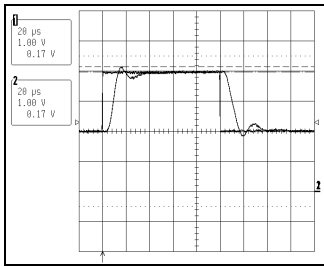

Figure 4: Observed transient response of the AVC.

Fig. 4 shows measured transient response of the AVC circuit for  $C_2 = 15$  nF. The prescribed 200 Hz bandwidth is attained. The transient over-shoot < 10% is acceptable.

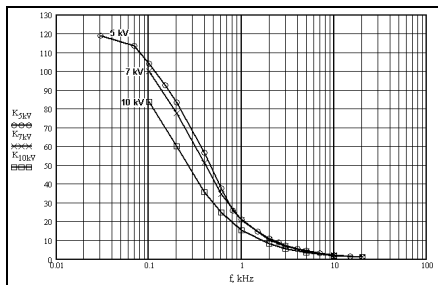

Figure 5: Suppression factor of a modulating signal applied to cavity gap. Curves stay for three values of DC voltage reference setting 5, 7 or 10 kV amplitude of the 5.5 MHz gap voltage, respectively.

Fig. 5 presents outcomes of experimental measurements of suppression factor for an external error due to closing the AVC feedback loop. This factor is defined as a ratio of apparent modulating amplitudes of a net voltage across gap with AVC feedback loop either open or closed, external probe voltage being externally applied to the gap. A visible decay of the suppression factor with frequency increasing is due to a variant regulation slope in a high-power tube amplifier.

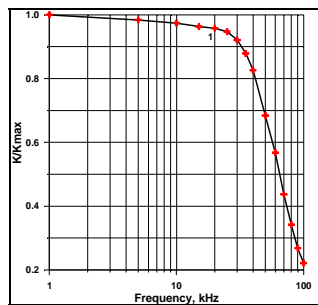

Figure 6: Observed amplitude-frequency transfer function of the amplitude regulation channel in the closed-AVC-loop configuration.

Finally, Fig. 6 shows observed amplitude-frequency response of the voltage amplitude regulation available with the AVC loop closed. Cutoff frequency at  $-3$  dB is around 50 kHz.

## AFC CIRCUIT

Block diagram of the AFC circuit around RF cavity of the U70 is shown in Fig. 7.

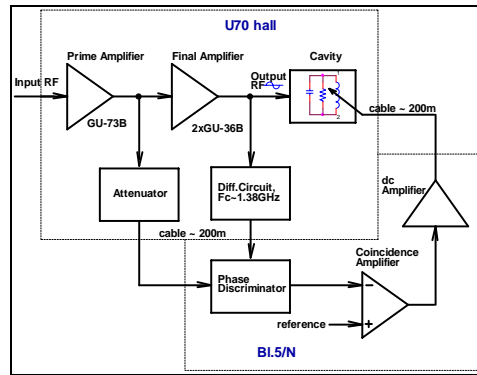

Figure 7: Block diagram of the AFC circuit.

The main job of the AFC circuit is to tune resonant frequency of a ferrite-loaded cavity in compliance with variation of external RF drive frequency and beam loading conditions.

The key unit of the AFC circuit is a phase detector (PD). It implements the AD8302 chip with a 58 dB dynamic range.

Output voltage of the AD8302 is directly proportional to a phase difference between two input RF signals. The input signals for the PD are RF voltages that are transmitted via equal-length cable routes from grid and anode of a tube in a final power amplifier. The grid voltage is pre-attenuated with a plain resistive divider. The anode voltage is attenuated on passing through a differentiator that causes a  $\pi/2$  phase shift required to set the working point of the PD to a center of its operational range.

Practically, the AFC circuit in question has the only one time-lagging section — a bias winding around ferrite with a cutoff frequency varying from 30 to 60 Hz through cycle. Therefore, the amplifier is designed as a plain proportional unit without any correcting circuits employed.

Fig. 8 presents transient response of the AFC circuit. The external signal pulse supplied was set equivalent to a phase shift of  $30^\circ$ .

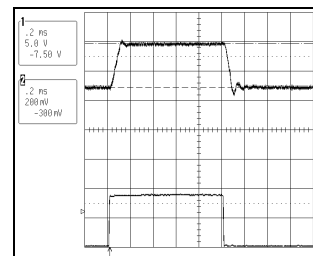

Figure 8: Observed transient response of the AFC.

Given the present configuration of RF cavities equipped with inductive stubs [2], the AFC circuit can follow rate of frequency variation roughly equal to 40 kHz/ms. This value safely exceeds by an order of magnitude the rate of 3.5 kHz/ms currently required for a routine operation of the U70.

As an outcome of this upgrade activity, RF system in the U70 has got a new AFC circuit whose capabilities supercede those of the former one by a few features:

1. Acceptable dynamic range of voltages at the PD is extended by a factor of 15.
2. Regulation speed is raised by a factor of 3.
3. Transient over-shoot is suppressed by a factor of 3.
4. Phase error due the RF variation from 5.5 to 6.1 MHz is cut down by a factor of 1.5.

Performance data of the thus renovated AFC circuit is specified in Table 2.

Table 2: Performance data of the AFC circuit

Operating range of accelerating voltages	0.2–10	kV
Transient time	0.3	ms
Max fractional regulation over-shoot	≤ 10	%
DC error at RF variation from 5.5 to 6.1 MHz	5	deg
Rate of frequency variation	40	kHz/ms
DC regulation slope	120	kHz/deg
Open-loop gain	270	

## HARDWARE

Outer view of electronic boards manufactured anew and tested is shown in Fig. 9.

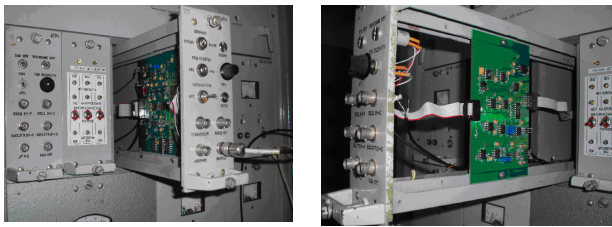

Figure 9: Low-level electronics of the AVC (left) and AFC (right) circuits.

All hardware parts of the feedback loops are installed in auxiliary buildings located outside of and around the ring hall of the U70.

## CONCLUSION

The renovation accomplished in 2006–7 of the two feedback circuits around all the 40 RF accelerating cavities of the U70 proton synchrotron of IHEP-Protvino was successfully tested with beam during machine runs. The design goals were achieved.

The updated systems have yielded the following performance results:

1. Higher apparent net RF voltage at beam.
2. Availability of a deeper (to 90%) operational amplitude modulation of the accelerating voltage.
3. Cancellation of a harmful cross-talk between the AVC and AFC loops through a beam transfer function.
4. Preparing better conditions for a foreseen closing amplitude beam feedback to damp unwanted longitudinal coherent quadrupole oscillations of bunches.

5. Gaining more flexibility in managing longitudinal phase portrait of bunches so as to cure beam instabilities and, say, space-charge effects close to transition.
6. Better reliability of routine operation of the RF accelerating system as a whole due to implementing up-to-date electrical-circuit and hardware solutions.

Commissioning of these renovated circuits constituted an important contribution to exercising a better control over longitudinal motion in the U70 that ultimately had a cumulative effect of squeezing a matched-bunch length at 50 GeV flattop from 35–40 to 12–15 ns (FW @0.9).

## REFERENCES

- [1] Yu. Ado et al, in Proc. of 8th All-Union Conference on Charged Particle Accelerators, Dubna, 1983, vol. 1, p. 146.
- [2] O. Lebedev, V. Chubrik, IHEP Preprint 93–143, Protvino, 1993.