

PROTON IMPROVEMENT PLAN – II: OVERVIEW OF PROGRESS IN THE CONSTRUCTION*

A. Klebaner[†], C. Boffo, S.K. Chandrasekaran, D. Passarelli, G. Wu
 Fermilab, Batavia, IL 60510, USA

Abstract

The Proton Improvement Plan II (PIP-II) project is an essential upgrade to Fermilab's particle accelerator complex to enable the world's most intense neutrino beam for LBNF/DUNE and a broad particle physics program for many decades to come. PIP-II will deliver 1.2 MW of proton beam power from the Main Injector, upgradeable to multi-MW capability. The central element of PIP-II is an 800 MeV superconducting radio frequency (SRF) Linac, which comprises a room temperature front end followed by an SRF section. The front end has been constructed and operated with beam in the PIP-II Injector Test facility (PIP2IT). The SRF section consists of five different types of cavities/cryomodules, including Half Wave Resonators (HWR), Single Spoke and elliptical resonators operating at state-of-the-art parameters. The first two PIP-II cryomodules, Half Wave Resonator (HWR) and Single Spoke Resonator 1 (SSR1) are installed in PIP2IT and have accelerated beam to above 17 MeV. PIP-II is the first U.S. accelerator project that will be constructed with significant contributions from international partners, including India, Italy, France, United Kingdom and Poland. The project was recently baselined, and site construction is underway

INTRODUCTION

The Fermi National Accelerator Laboratory (Fermilab) accelerator complex powers research into the fundamental nature of the universe and is the only one in the world to produce both low- and high-energy neutrino beams for science. The Strategic Plan for U.S. Particle Physics in the Global Context [1] by the Particle Physics Project Prioritization Panel (P5) calls for a performance upgrade of the Fermilab accelerator complex to support a world-leading neutrino program, while maintaining high-reliability operations through the rejuvenation of aging systems within this complex and providing a platform for future enhancements.

The Proton Improvement Plan II, or PIP-II, Project is an essential enhancement to the Fermilab accelerator complex to deliver higher-power proton beams to the neutrino-generating target that serves the Deep Underground Neutrino Experiment (DUNE) that will be located within the Long-Baseline Neutrino Facility (LBNF). It also provides a more capable and reliable front end to the Fermilab accelerator complex to support the future scientific efforts of the high energy physics community [2].

* Work supported by the U.S. Department of Energy, Office of Science, Office of High Energy Physics, under U.S. DOE Contract No. DE-AC02-07CH11359.

[†] klebaner@fnal.gov

PIP-II is the first particle accelerator on U.S. soil built with significant in-kind contributions from international partners. Institutions in France, India, Italy, Poland and the U.K. are contributing to the project, bringing specific expertise and capabilities in accelerator technologies and established track records in international accelerator projects.

OVERVIEW OF THE PIP-II IN-KIND CONTRIBUTION

PIP-II benefits from in-kind contribution by many partners. International partnerships have been formed with the following institutions for in-kind contributions of radio frequency (RF), superconducting radio frequency (SRF), cryogenic infrastructure and other significant components:

- Department of Atomic Energy (DAE) in India
- Istituto Nazionale di Fisica Nucleare (INFN) in Italy
- Science and Technology Facilities Council as part of UK Research Innovations (STFC-UKRI) in the United Kingdom
- Commissariat à l'Énergie Atomique et aux Énergies Alternatives (CEA) and Centre National de la Recherche Scientifique / Institut National de Physique Nucléaire et de Physique des Particules (CNRS/IN2P3) in France
- Wrocław University of Science and Technology (WUST)

All agreements with international partners are bilateral and all contributions are in-kind. The scope of in-kind deliverables is included in two of the five technical systems that make up the PIP-II project: Superconducting Radio Frequency and Cryogenics, and Accelerator Systems. The division of scope during the construction phase with all international partners was determined by the collaborating parties based on capabilities and interests of the collaborating institutions and maturity of negotiations towards formal agreements. PIP-II international partners contribute world-leading expertise and capabilities which are essential for the success of PIP-II.

PERFORMANCE GOALS

Design criteria for PIP-II are established on the basis of the P5 report [1] as follows:

- Deliver >1 MW of proton beam power from the Fermilab Main Injector, over the energy range of 60 - 120 GeV, at the start of operations of the LBNF/DUNE program
- Provide a platform for eventual extension of beam power to LBNF/DUNE to >2 M@

- Sustain high reliability operations of the Fermilab accelerator complex throughout the initial phase of LBNF/DUNE operations
- Support the currently operating and envisioned 8 GeV program at Fermilab including Mu2e, g-2, and the suite of short-baseline neutrino experiments
- Provide a flexible platform for long-range development of the Fermilab complex

These gains and capabilities will be achieved and supported through the increase of the Fermilab Booster accelerator, or Booster, beam intensity by roughly 50% compared to current operation (number of protons extracted per Booster cycle from 4.3×10^{12} to 6.5×10^{12} , the reduction of the Main Injector accelerator (MI) cycle from 1.33 s to 1.2 s, and the increase of the Booster repetition rate from 15 to 20 Hz. A site view of the PIP-II complex is shown in Fig. 1.

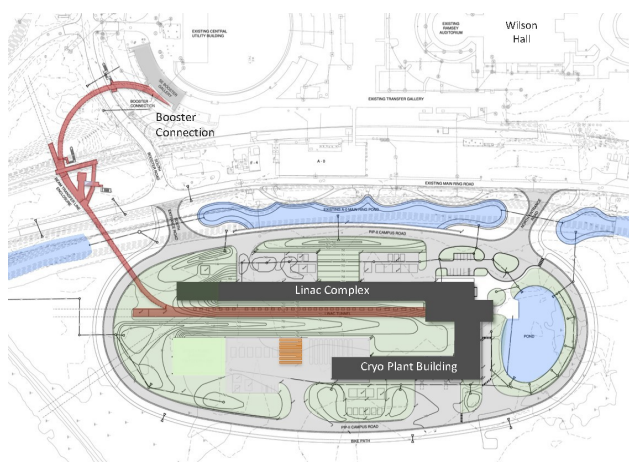

Figure 1: Site view of the PIP-II complex.

The PIP-II design is based on an 800-MeV superconducting radio frequency (SRF) linear accelerator, or Linac, injecting into the existing 8-GeV Booster via a newly constructed Linac-to-Booster transfer line and Booster injection area, and augmented by upgrades to the MI and Recycler Ring (RR) to allow higher beam intensities enabled by the Linac.

LINAC

The high-level performance requirements for the PIP-II Linac are given in Table 1. It consists of a 2.1 MeV warm front end and a superconducting section comprised of twenty-three fully segmented SRF cryomodules. The Linac is being constructed of components capable of operating in continuous wave (CW) and pulsed RF modes. Initial operation of the Linac is planned for CW RF mode with pulsed beam. The Linac is designed with an energy of 833 MeV that can provide significant margin for beam loss and provide opportunities for further performance enhancements in support of the Fermilab scientific program. A room temperature section, or Warm Front End, accelerates the beam to 2.1 MeV and creates the desired bunch structure for injection into the superconducting section.

The superconducting section contains 5 unique types of cryomodules operating at 3 different RF frequencies. The SRF cryomodules include Half Wave Resonator cavities at 162.5 MHz, two types of Single Spoke Resonator cavities at 325 MHz, and two types of elliptical cavities at 650 MHz, as well as normal and superconducting magnets. The new SRF Linac is supported by a 2.5 kW @ 2K cryogenic plant. Figure 2 shows the PIP-II Linac with the contributions from partners. In the following sections, emphasis is given to the main elements of the Linac design and status.

Table 1: PIP-II Performance Goals

Performance Parameter	Value	Units
Delivered Beam Energy	800	MeV
Beam Particles	H-	
Beam Pulse Length	0.54	ms
Particles per Pulse	6.7	10^{12}
Pulse repetition Rate	20	Hz
Average Beam Current	2	mA
Maximum Bunch Intensity	1.9	10^8
Maximum Bunch Rep Rate	162.5	MHz
Bunch Pattern	Prog and Arbitrary	
RF Frequency	162.5 harmonic	
Bunch Length (RMS)	< 4	ps
Transverse Emittance	≤ 0.3	mm-rad
Longitudinal Emittance (RMS)	≤ 0.3	mm-rad

Warm Front End

The Warm Front End (WFE) consists of two H- ion sources (one operational and one in-situ spare), a Y-shaped 2 m long Low Energy Beam Transferline (LEBT), a 162.5 MHz CW RFQ that accelerates the H- beam to 2.1 MeV and a 14-meter-long Medium Energy Beam Transfer (MEBT) line including diagnostic devices and a bunch-by bunch chopper system that removes undesired bunches, leaving the beam current at up to 2 mA (averaged over a few μ s) for further acceleration [3].

The H- beam originates from a 2 mA (nominal, 15 mA maximum) DC ion source and is transported through the LEBT to a normal-conducting RFQ, where it is bunched and accelerated to 2.1 MeV. The RFQ operates in a RF CW mode [4, 5].

The MEBT transports and matches the beam to the first SRF cryomodule. In the MEBT, a bunch-by-bunch chopper creates the required bunch patterns by removing 60-80% of the bunches according to a pre-programmed timeline. To accommodate possible upgrades, all elements of the WFE are designed for beam currents of up to 10 mA. A shield wall, located in the downstream end of the MEBT, shields the WFE from radiation generated in the main Linac, allowing servicing of the ion sources without interrupting the Linac beam. Beamline layout of the WFE through the first superconducting cryomodule is shown in Fig. 3.

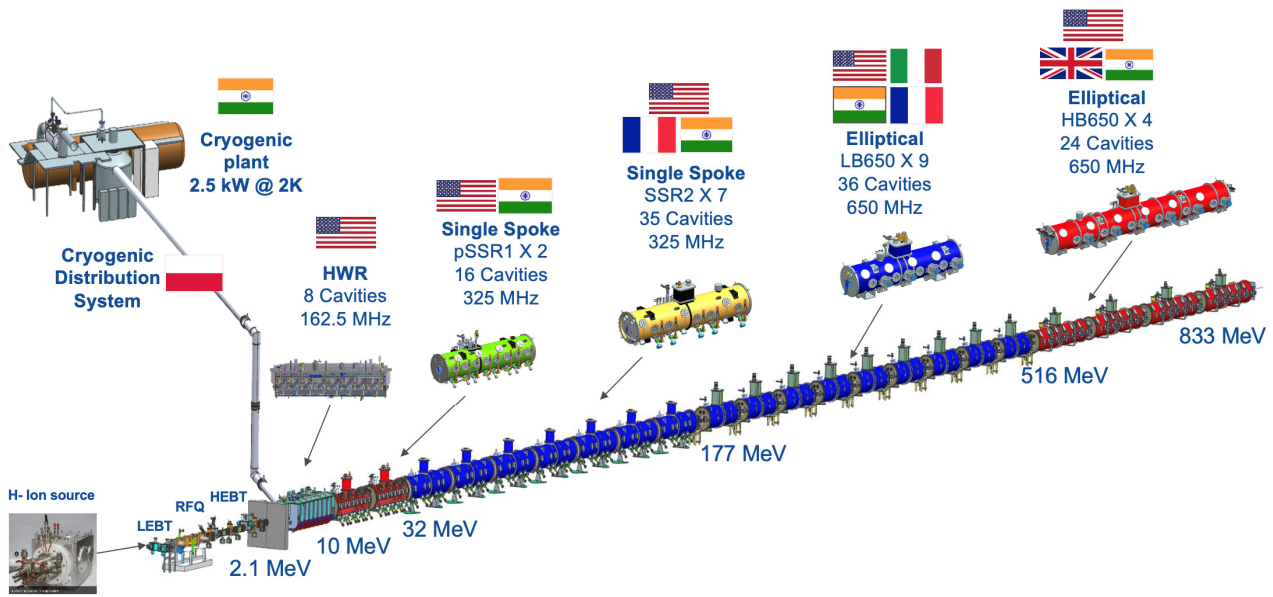

Figure 2: PIP-II Linac.

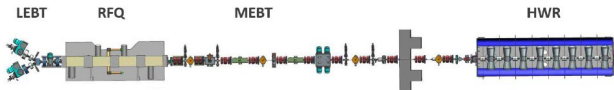

Figure 3: PIP-II WFE including Half Wave Cryomodule (HWR).

The WFE [6] in its nearly final configuration has been commissioned [7] and fully tested at the PIP-II Injector Test facility (PIP2IT) and has demonstrated required performance including a beam pattern suitable for injection into the Booster for LBNF operation [8].

Superconducting Section

Major parameters of the PIP-II superconducting cavities are given in Table 2. The β values represent the optimal betas where the corresponding cavity delivers the maximum accelerating voltage. The quality factor for the elliptical cavities challenges the start-of-the-art in SRF technology.

Table 2: Cavity Parameters

Cavity Type	β	ϕ , MHz	Q_0 , 10^9	E_{peak} , MV/m	Qty, #
Half Wave	0.11	162.5	8.5	9.7	8
Single Spoke 1	0.22	325	8.2	10	16
Single Spoke 2	0.47	325	8.2	11.5	35
Elliptical β_{low}	0.61	650	240	16.8	36
Elliptical β_{high}	0.92	650	330	18.7	24

Half Wave Resonators

The overall design of the half-wave cavity cryomodule provided by Argonne National Laboratory is an evolution of the top-loaded box cryomodules used successfully for an energy upgrade of ATLAS in 2009 [9] and for an intensity upgrade of ATLAS in 2014 [10], see Fig. 4.



Figure 4: HWR cryomodule.

Beam dynamics optimization determined an optimal β of 0.11 for the HWR cavities. Cavity design is based on recent SRF technology for TEM-class structures developed at Argonne National Laboratory. Highly optimized electromagnetic parameters that maximize the gradient while maintaining low dynamic cryogenic loads and peak surface fields were achieved using a conical shape for both the inner and outer conductors. The niobium cavity is integrated with the stainless-steel helium vessel as shown in Fig. 5. The regions of the cavity with appreciable surface electromagnetic fields are formed from high purity (residual resistance ratio, $RRR > 250$), 0.125-inch-thick niobium sheet.

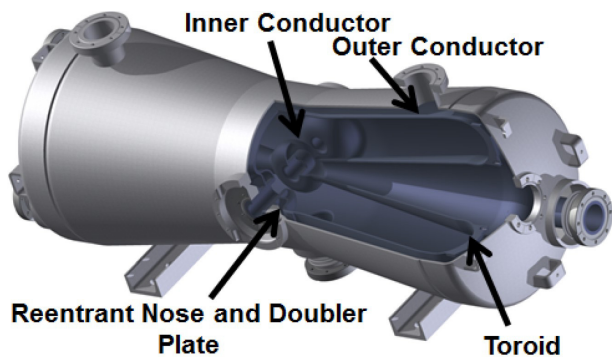

Figure 5: HWR dressed cavity.

HWR cryomodule was tested at the PIP2IT facility. All operated cavities met the maximum nominal operating gradient plus a 10-15% margin without field emission or multipacting, see Fig. 6.

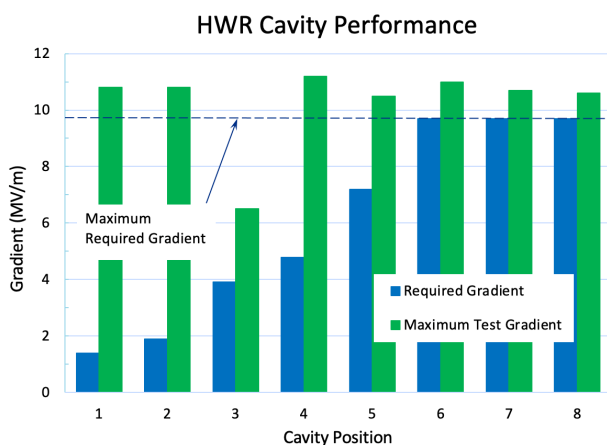

Figure 6: HWR cavity gradient performance.

The HWR cryomodule has eight superconducting solenoids, each with one main focusing coil in-series with polarity-reversing bucking coils and four correction coils. All magnet packages met or exceeded performance requirements by up to 50% at PIP2IT.

Single Spoke Resonators

Acceleration from 10 to 35 MeV utilizes superconducting cavities with $\beta=0.22$ operating at 325 MHz, referred to as a Single Spoke Resonator of type 1 (SSR1), see Fig. 7. Spoke resonators have a central electrode on the axes perpendicular to particle motion, breaking the axial symmetry of the cavity. The bare cavity shell is fabricated from high-purity niobium sheets of 3 mm uniform thickness. All parts are formed and machined to follow the RF domain shape and are joined by electron-beam welding. The cavity has four stainless steel flanges that attach to the helium vessel, connected to the niobium using copper-brazed joints.



Figure 7: SSR1 cavity.

The SSR1 cavities are a Fermilab design, fabricated in US industry and DAE, and processed at Argonne National Laboratory. Figure 8 shows the high Q at high gradient and field emission free cavity fabricated at IUAC/BARC with the highest cavity Q performance to date. The cavities have been tested extensively including with beam as part of the integrated SSR1 cryomodule. All cavities reached Phase I gradients (corresponding to SSR1 cryomodule #1) with 15% margin. At the conclusion of PIP2IT beam operations, cavities were tested to their Phase II gradients (representing the gradients in SSR1 cryomodule #2), see Fig. 9. All ancillary systems (fast and slow tuners, couplers, magnets) performed well and met or exceeded specifications.

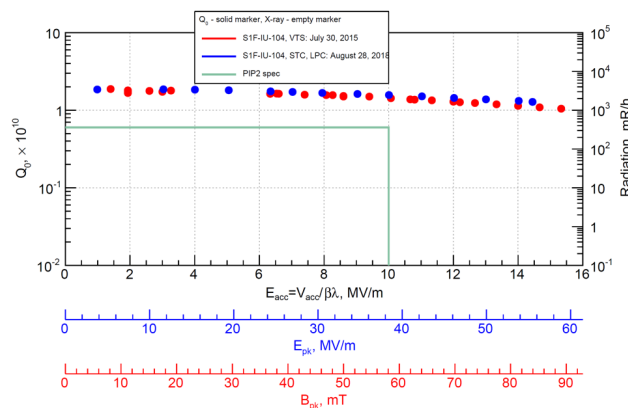

Figure 8: SSR1 IUAC/BARC cavity high Q at high gradient with no field emission.

All cryomodules except HWR use a new type of cryomodule design based on a room temperature supported strongback [11] and utilize the same conceptual design for thermal shields, support posts, vacuum vessel, and cryogenic piping including cryogenic heat exchanger, designed to the combined requirements of all cryomodules across the range of required flowrates.

Acceleration from 35 to 185 MeV utilizes superconducting cavities with $\beta=0.47$ operating at 325 MHz, referred to as a Single Spoke Resonator of type 2 (SSR2), see Fig.10.

Content from this work may be used under the terms of the CC BY 4.0 licence (© 2022). Any distribution of this work must maintain attribution to the author(s), title of the work, publisher, and DOI

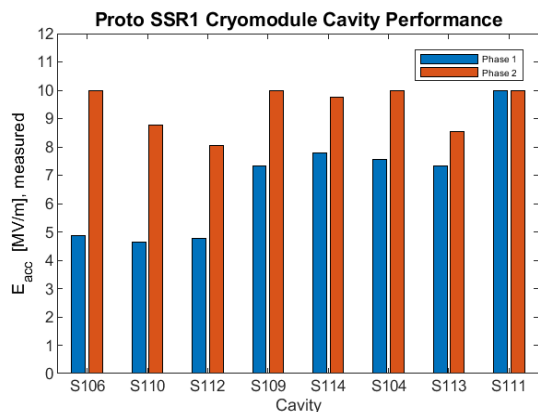

Figure 9: SSR1 cavity gradient performance at PIP2IT.

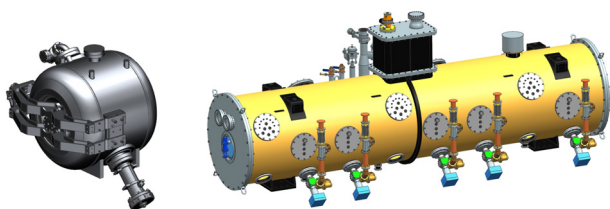

Figure 10: SSR2 cavity and cryomodule.

Cavity design was performed using an integrated design team consisting of CNSR/IJCLab, DAE and Fermilab with prototype jacketed cavities fabricated and processed in industry. Each SSR1 cryomodule contains four solenoid-based focusing lenses operating at 2K. SSR2 cryomodules have three focusing lenses of the same design.

Low Beta 650 MHz

Two families of 5-cell elliptical cavities, operating at 650 MHz, provide acceleration from 185 MeV to 800 MeV. Elliptical cavities with a $\beta=0.61$ are designated LB650 cavities and provide energy gains of up to 11.9 MeV. The baseline processing recipe for 650 MHz cavities include nitrogen doping to improve cavity performance. Additional measures to ensure that cavity Q_0 can be retained as much as possible include a magnetic shield design, good magnetic hygiene and cryomodule fast cool-down to reduce magnetic field trapped inside of the niobium. LB650 cavity acceptance Q_0 is 2.4×10^{10} with an operating gradient of 16.9 MV/m which is state-of-the-art for cavities with $\beta < 1$.

The cavity electromagnetic boundary profile comprises a circular arc at the equator, elliptic arc at the iris, and a straight-line segment connecting the arcs. The cell shape minimizes the ratio of peak surface magnetic and electric fields to the accelerating gradient. The cavity iris aperture was chosen as 88 mm as a compromise between the peak field ratios, shut impedance and cell-to-cell coupling, and cavity handling during processing. An integrated design team consisting of INFN, DAE, and Fermilab designed the cavities.

High Beta 650 MHz

Elliptical cavities with a $\beta=0.92$ are designated HB650 cavities and provide energy gains of up to 19.9 MeV. With cavity acceptance Q_0 of 3.3×10^{10} and an operating gradient of 18.8 MV/m, these cavities also approach the state-of-the-art for $\beta < 1$ cavities. Like the LB650 cavities, the cell shape minimizes the ratio of peak surface magnetic and electric fields to the accelerating gradient with a cavity iris of 118 mm.

The prototype High Beta 650 MHz cryomodule (pHB650 CM) is designed by an integrated design team, consisting of Fermilab, CEA, UKRI-STFC, and DAE. The manufacturing and assembly of this prototype cryomodule will be done at Fermilab, whereas the production cryomodules will be manufactured and/or assembled by UKRI-STFC, DAE, or Fermilab. Similar to the prototype SSR1 cryomodule (pSSR1 CM), this cryomodule is based on a room temperature strong-back supporting the cold-mass and share the same conceptual design for the thermal shield, support post, vacuum vessel, and cryogenic piping.

Couplers

A capacitive adjustable 7 kW RF coupler prototype has been designed, constructed, and successfully tested for HWR. A 1 kV DC voltage bias suppresses multipacting in the entire range of operating power, with the coupler antenna at a negative potential relative to the outer conductor.

The SSR1 and SSR2 cavities use the same unified 325 MHz coaxial fundamental power coupler design, based on modifications of successfully built and tested prototype designs [12]. The coupler consists of a vacuum (cold) end assembly, air side (room temperature) assembly, and a DC block, with a ceramic window separating the vacuum and air portions, see Fig. 11. The antenna and window are actively air-cooled to room temperature or above. The couplers were fully tested in the prototype SSR1 cryomodule at PIP2IT.

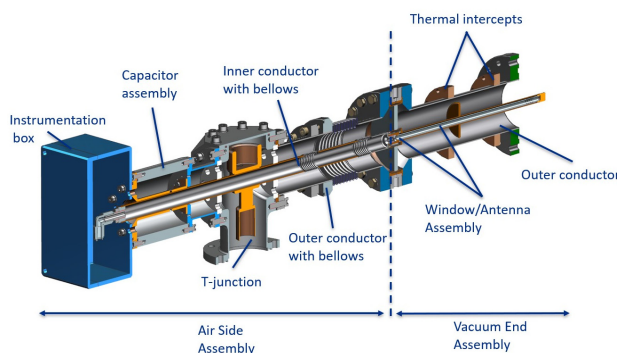

Figure 11: Cut-view of 325 MHz PIP-II coupler.

An integrated design team consisting of CEA, CNRS/IJC, DAE, and Fermilab participated in the design effort for the 50 kW CW RF power couplers for the superconducting LB650 and HB650 cavities. To meet project requirements two different designs of the couplers

were proposed, one is a conventional design with copper plated stainless-steel walls. In the second design (EM-shielded) a copper screen is used to shield stainless steel wall from electromagnetic field. For prototyping, two couplers of each type were built and tested at 50 kW with full reflection at different reflection phases. In each test the assembly of two couplers were processed with DC bias up to +5 kV, starting with short pulses and ramping power up to 100 kW. A final run of 2 hours in CW mode at 50 kW to reach equilibrium temperature regime and qualify couplers was completed. One pair of couplers was also processed without DC bias. All four couplers demonstrated full requirements and qualified. Based on test results the conventional coupler with some modifications was chosen as a baseline design. The modified version of the coupler is now ordered for the prototype of HB650 cryomodule.

Tuners

The slow tuner for the HWR is a pneumatically actuated device which compresses the cavity at the beam ports. The slow tuner is based upon multiple prototype tests conducted at both room temperature and 4K. Tests of the assembly verified the slow tuner design and the cavity frequency tuning calculations, determining 2K performance. The RF power margin was chosen to sufficiently control microphonic-induced RF phase noise (mainly related to helium pressure fluctuations) without a fast tuner at the nominal cavity loaded bandwidth of 70 Hz. All HWR cavity tuners exceeded the 100 kHz tuning range, some by as much as 100% at PIP2IT.

SSR1 and SSR2 share the same tuner design. Considering tuner systems [13] and experiences with previous SSR1 tuners [14], a lever mechanism was chosen for resonant frequency control in both operating conditions: CW and pulsed regime [15]. Resonant frequency is changed by adjusting spacing between the cavity end-wall and the spoke, done by acting on the cavity sidewall connected to the helium vessel by a flexible joint (bellows). Controlling this gap by elastically deforming the cavity niobium structure, the resonant frequency must be within the ± 20 Hz from the nominal value of 325 MHz. Tuner range and hysteresis were measured at 2K at PIP2IT and demonstrated performance according to specifications, see Figure 12 and Figure 13.

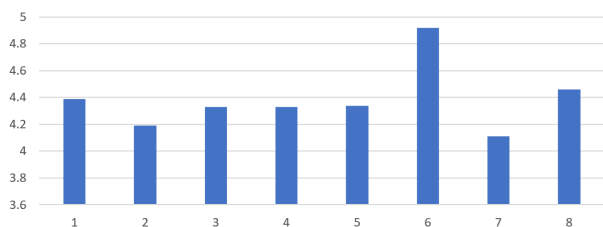

Figure 12: SSR1 slow tuner resolution of each cavity (average resolution is 4.4 Hz/step).

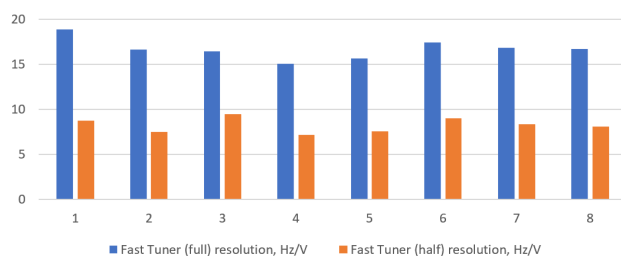

Figure 13: SSR1 fast tuner resolution (average value is 16.7 Hz/V).

LB650 and HB650 cavities also share the same tuner design. Each cavity will be equipped with a tuning system consisting of a double lever slow tuner for coarse frequency tuning and a piezoelectric actuator for fine frequency tuning. One dressed cavity equipped with an SRF tuner has been tested in the horizontal test stand at Fermilab.

PIP-II INJECTOR TEST

The PIP-II Injector Test facility (PIP2IT) provides a test bed for the measurement and characterization of PIP-II cryomodules and associated support systems, see Figure 14. PIP2IT goals include:

- Test critical technologies and other technical systems
- Validate designs and if necessary, implement findings in the design to address deficiencies and improve performance
- Accelerate beam in SRF cryomodules
- Validate beam optics, quantify beam parameters, and confirm results of numerical simulations
- Gain experience with installation, integrated testing, and operation of equipment and develop and validate corresponding processes and procedures.

Tests at PIP2IT included not only cold operation of all major components but also successful beam operation with beam successfully passed through the cryomodules (HWR and SSR1) on the first attempt at nearly full transmission, up to 17 MeV, see Fig. 15.

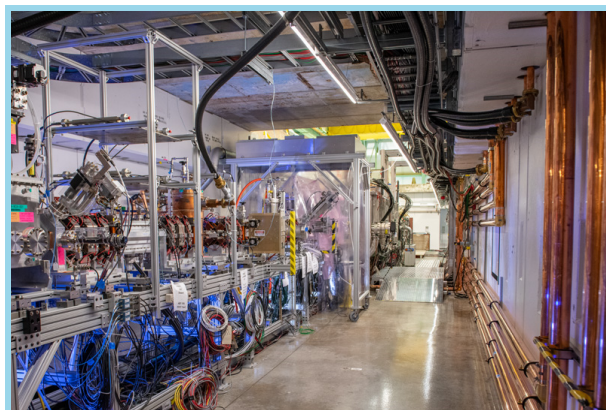

Figure 14: PIP-II Injector Test (PIP2IT).

Content from this work may be used under the terms of the CC BY 4.0 licence (© 2022). Any distribution of this work must maintain attribution to the author(s), title of the work, publisher, and DOI

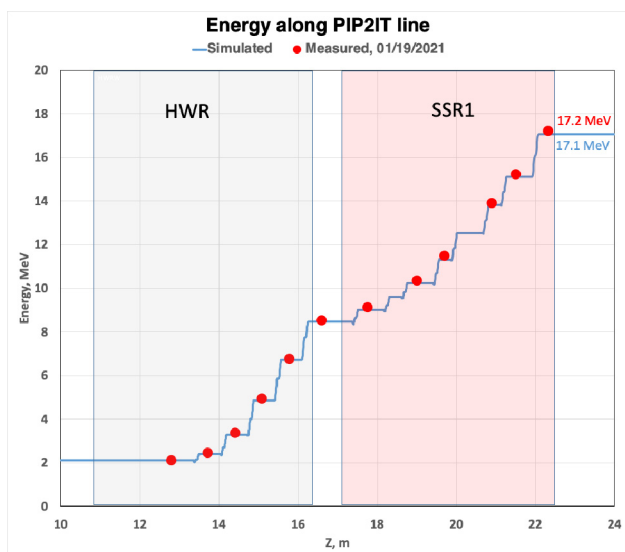

Figure 15: Energy profile at PIP2IT (simulated and measured).

Magnets were tested individually and as a unit (solenoids and correctors) and met requirements. Alignment of SRF cavities and solenoids also met requirements. At 2K, alignment of beamline components (cavities and solenoids) was verified. Transverse displacements were well within the 0.5 m tolerance and the vertical displacement was 1.2 ± 0.1 mm, matching the 1.2 mm displacement expected at cool-down.

PIP-II beam design parameters were demonstrated as well as validation of critical technologies. International partner deliverables were seamlessly integrated.

PIP-II STATUS

DOE approved the PP-II performance baseline (CD-2) in December 2020. To mitigate impacts related to the Covid-19 pandemic and to support the baseline schedule, the project received authorization (CD-3a approval) in March 2021 for long lead procurements. A DOE CD-3 Independent Project Review, which assesses readiness to commit all the resources necessary, within the funds provided, to execute the project is planned for Q1FY22.

The overall PIP-II design is expected to be approximately 81% complete (representing a percentage of the value of overall scope requiring design) at CD-3. The PIP-II baseline project early CD-4 date, representing attainment of all key performance parameters is expected in December 2028. Figure 16 presents a summary project schedule.

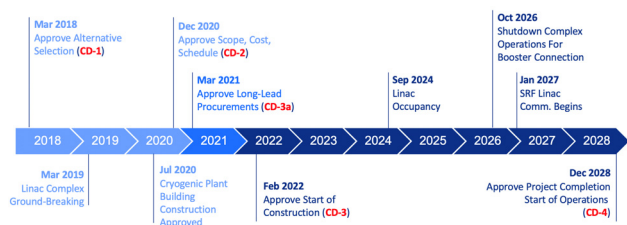

Figure 16: PIP-II major milestones.

CONCLUSION

PIP-II is an essential enhancement to the Fermilab accelerator complex, powering the world’s most intense high-energy neutrino beam for DUNE and the first US-based accelerator built with significant international contributions. The increased beam power will position Fermilab as the leading laboratory in the world for accelerator-based neutrino experiments. The PIP-II International Partnership is making excellent progress towards completion of the design, demonstration of critical technologies, and project construction.

ACKNOWLEDGEMENTS

Work supported by the U.S. Department of Energy, Office of Science, Office of High Energy Physics, under U.S. DOE Contract No. DE-AC02-07CH11359.

REFERENCES

- [1] Building for Discovery: Strategic Plan for U.S. Particle Physics in the Global Context. Report of the Particle Physics Project Prioritization Panel (P5), Report FNAL-P5, May 2014. https://www.usparticlephysics.org/wp-content/uploads/2018/03/FINAL_P5_Report_053014.pdf
- [2] Proton Improvement Plan-II, Research program, Fermilab. <https://pip2.fnal.gov/about/research-program/>
- [3] A. V. Shemyakin *et al.*, “Status of the Warm Front End of PIP-II Injector Test”, in *Proc. 8th Int. Particle Accelerator Conf. (IPAC’17)*, Copenhagen, Denmark, May 2017, pp. 2421-2424. doi:10.18429/JACoW-IPAC2017-TUPVA138
- [4] D-Pace, Inc., <http://www.d-pace.com/>; A. Shemyakin *et al.*, “PIP-II injector test’s low energy beam transport: Commissioning and selected measurements”, *AIP Conf. Proc.*, vol. 1869, p. 050003 (2017). <https://doi.org/10.1063/1.4995784>
- [5] J.-P. Carneiro *et al.*, “Beam Measurements at the PIP-II Injector Test LEBT”, in *Proc. North American Particle Accelerator Conf. (NAPAC’16)*, Chicago, IL, USA, Oct. 2016, pp. 636-638. doi:10.18429/JACoW-NAPAC2016-TUPOB64
- [6] S. P. Virostek *et al.*, “Final Design of a CW Radio-frequency Quadrupole (RFQ) for the Project X Injector Experiment (PXIE)”, in *Proc. North American Particle Accelerator Conf. (NAPAC’13)*, Pasadena, CA, USA, Sep.-Oct. 2013, paper WEPMA21, pp. 1025-1027.
- [7] L.R. Prost *et al.*, “PIP-II Injector Test Warm Front End: Commissioning Update,” Report Fermilab-Conf-18-017-AD, USA. <https://www.osti.gov/servlets/purl/1452810>
- [8] E. Pozdeyev *et al.*, “FRIB Front End Construction and Commissioning”, in *Proc. 9th Int. Particle Accelerator Conf. (IPAC’18)*, Vancouver, Canada, Apr.-May 2018, pp. 58-62. doi:10.18429/JACoW-IPAC2018-MOZGBF1
- [9] J. Fuerst *et al.*, “Assembly installation and commissioning of the ATLAS upgrade cryomodule,” in *Advances in Cryogenic Engineering: Transactions of the Cryogenic Engineering Conference-CEC*, vol. 55A, CP1218, J.G. Weisend

- et al., Eds., American Institute of Physics, New York, NY, USA, 2010, p. 815.
- [10] Z. Conway *et al.*, “Assembly and commission of a new SRF cryomodule for the ATLAS intensity upgrade,” *AIP Conf. Proc.*, vol. 1573, J.G. Weisend *et al.*, Eds., p. 1829 (2014). <https://doi.org/10.1063/1.4860930>
- [11] T. H. Nicol *et al.*, “SSR1 Cryomodule Design for PXIE”, in *Proc. North American Particle Accelerator Conf. (NAPAC'13)*, Pasadena, CA, USA, Sep.-Oct. 2013, paper THPMA09, pp. 1373-1375.
- [12] S. Kazakov *et al.*, “Latest Progress in Designs and Testings of PIP-II Power Couplers”, in *Proc. 19th Int. Conf. RF Superconductivity (SRF'19)*, Dresden, Germany, Jun.-Jul.2019, pp. 263-266. doi:10.18429/JACoW-SRF2019-MOP080
- [13] R. Paparella, “Overview of Recent Tuner Development on Elliptical and Low-Beta Cavities”, in *Proc. 17th Int. Conf. RF Superconductivity (SRF'15)*, Whistler, Canada, Sep. 2015, paper FRAA01, pp. 1425-1431.
- [14] Y. M. Pischnalnikov *et al.*, “Tests of a Tuner for a 325 MHz SRF Spoke Resonator”, in *Proc. 24th Particle Accelerator Conf. (PAC'11)*, New York, NY, USA, Mar.-Apr. 2011, paper TUP080, pp. 973-975.
- [15] D. Passarelli, “SSR1 Tuner Mechanism: Passive and Active Device”, in *Proc. 27th Linear Accelerator Conf. (LIN-AC'14)*, Geneva, Switzerland, Aug.-Sep. 2014, paper TUPP052, pp. 541-543.